

Notice Inviting Tender for Fabrication & Erection of New Inter-connection Line (Suction, Extraction, Discharge, ARC By-pass Line, Balancing Line & Utility Lines) for installation of New BFW Pump at NFL, Panipat

INDEX

S. No.	Annexure no.	Particulars	Page no.
1.	Annexure-I	COVERING LETTER OF NIT	2 – 7
2.		SPECIAL TERMS AND CONDITIONS	8 – 12
3.		TECHNICAL SCOPE OF WORK	13 - 21
4.		SCHEDULE OF RATES	22
5.	Annexure-II	DECLARATION FORM-I	23
6.	Annexure - III	DECLARATION FORM-II	24 – 25
7.	Annexure - IV	DECLARATION FORM-III	26 – 27
8.	Annexure-V	REGISTRATION OF GST NUMBER	28
9.	Annexure-VI	AFFIDAVIT	29
10.	Annexure-VII	ELIGIBILITY CRITERIA	30 – 33
11.	Annexure-VIII	EVALUATION CRITERIA	34
12.	Annexure-IX	DEFINITIONS OF TERMS	35 – 38
13.	Annexure-X	GENERAL TERMS & CONDITIONS (GTC/GTCC)	39 – 55
14.	Annexure-XI	PERFORMA FOR PROPRIETORSHIP AFFIDAVIT	56
15.	Annexure-XII	PROCUREMENT FROM A BIDDER WHICH SHARES A LAND BORDER WITH INDIA	57 – 58
16.		Form-I	59
17.		Form-II	60
18.	ANNEXURE- XV	SECURITY DEPOSIT-CUM-PERFORMANCE BANK GUARANTEE FORMAT	61 – 62
19.	Annexure-XIX	E-Tendering Guidelines	63 – 66
20.	Annexure-XX	CONTRACT AGREEMENT	67 – 72
21.	Annexure-XXII	NO CLAIM CERTIFICATE	73
22.	Annexure-XXIII	CISF GATE PASS CLEARANCE	74
23.	Annexure-XXV	PREFERENCE TO MAKE IN INDIA	75 – 81
24.	Annexure-XXVI	MODEL CLAUSES OF TENDERS	82 – 83
25.	Annexure-XXVII	PUBLIC PROCUREMENT POLICY FOR MICRO AND SMALL ENTERPRISES (MSMEs)	84 - 86
26.		APPLICABLE DRAWINGS AND WPS	87-93

Notice Inviting Tender

For the job of

Fabrication & Erection of New Inter-connection Line (Suction, Extraction, Discharge, ARC By-pass Line, Balancing Line & Utility Lines) for installation of New BFW Pump at NFL, Panipat.

NIT reference no.	NFL/PT/M/A/13.442 Dt.21.05.2024
Estimated Cost	75,81,500.00/- including GST
Last date and Time of issue of Tenders	13/06/2024, 03:00 p.m.
Last date and time of Receipt of Tenders	13/06/2024, 03:00 p.m.
Date and time of Opening of Tenders	14/06/2024, 03:30 p.m.
Place of receipt and Opening of Tenders	Office of : DGM (M&C), NFL Panipat unit
Issuing Department	Ammonia (Mechanical)



नेशनलफर्टिलाइज़र्सलिमिटेड
(भारत सरकारका उपक्रम)

National Fertilizers Limited

(A Govt. of India Undertaking)

गोहानारोड, पानीपत-132 106 (हरियाणा)

Gohana Road, Panipat- 132 106(Haryana) India

An ISO-9001, 14001 & OHSAS-18001 Unit

GSTIN: 06AAACN0189N1Z8



फैक्स : (91)180-2652515

फोन : (91)180-2652481,83,85

ईमेल: nflpanipat@nfl.co.in
वेबसाईट: www.nationalfertilizers.com

NIT FOR NON PREQUALIFIED PARTIES

Annexure-I

Ref. No.: NFL/PT/M/A/13.442

Dated: 21.05.2024

**COVERING LETTER OF NIT
INSTRUCTIONS TO THE TENDERER AND TENDER CONDITIONS**

To

Sub: Notice Inviting Tender for Fabrication & Erection of New Inter-connection Line (Suction, Extraction, Discharge, ARC By-pass Line, Balancing Line & Utility Lines) for installation of New BFW Pump at NFL, Panipat.

Dear Sir,

E-tenders are invited for the work as detailed below:

1.	Name of Work	As mentioned above.
2.	Earnest Money Tender received without EMD is liable to be rejected (See Note**)	Tenderer to submit EMD of Rs. 1,00,000/- in the form of crossed Demand Draft / Banker's Cheque only, issued by any scheduled bank except rural and co-operative bank in favour of National Fertilizers Ltd, Panipat Unit, payable at Panipat. RTGS/NEFT is also accepted Cheque shall not be accepted in any case. Name: National Fertilizer Limited Account No.: 10565845486 Bank Name: SBI IFSC Code: SBIN0001620 Branch Address: Main Branch, GT Road, Panipat
3.	Estimated Value of the Work	Rs. 75,81,500.00/- including GST
4.	Validity of Tender	120 days from the date of opening of Technical Bid for the acceptance
5.	(a) Validity of Contract	12 months
	(b) Time of Completion	As per STC Clause No.5
6.	Last date and Time of issue of Tenders	13/06/2024, 03:00 PM
7.	Last date and time of Receipt of Tenders	13/06/2024, 03:00 p.m.
8.	Date and time of Opening of Tenders	14/06/2024, 03:30 p.m.

9.	Place of receipt and Opening of Tenders	Office of DGM (M&C), NFL Panipat unit
----	---	---------------------------------------

10. Tender Documents may be downloaded from our website www.nationalfertilizers.com or CPP portal www.eprocure.gov.in. In case documents are downloaded directly from the said websites, and EMD shall be submitted along with tender documents in envelope No 1 (envelope applicable for manual tendering only).

Parties are advised to visit NFL website regularly. Any amendment / corrigendum to the above NIT will be displayed on aforesaid website only.

11. All requests for interpretation, clarification & queries in connection with tender shall be addressed, in writing to DGM (M&C) at least 7 (Seven) days prior to the closing date of the tender.
12. The Tenderer may visit the site, acquaint himself fully of the job and site condition, if required, and no claim, whatsoever, will be entertained on the plea of ignorance of difficulties involved in the execution of the work.
13. The rates should be quoted item wise for the complete Scope of Work as per Performa 'Schedule of Rates'. The rates should be quoted only in the units given in the Schedule of Rates and should be indicated both in words as well as figures. The rates quoted shall be valid for 120 days from the date of opening of Technical bid for the acceptance.
14. In case of any discrepancy, the rates quoted in words shall be treated as final. Any corrections made in the prices shall be authenticated with signatures at all places. The Tenderer shall have to submit the Schedule of Rates Performa duly filled in, failing which their Price bid will not be acceptable.
15. The tenderer shall quote single rate against each item and not the multiple rates in the Schedule of Rates. Any tender with the multiple rates quoted will be summarily rejected. Price should be quoted strictly as per the Performa enclosed for Schedule of Rates.
16. National Fertilizers Limited reserves the right to reject any or all tenders without assigning any reason whatsoever and are not bound to accept the lowest tender. The tender can be split between two or more tenderer without assigning any reason thereof as per the requirement on case-to-case basis.
17. Incomplete Tenders or Tenders not accompanied with the required Details / Documents / Tender fee/ EMD or Tenders received late would be liable to be rejected without any further reference whatsoever.
18. Submission of Tenders:
 - i) No oral, telephonic, fax or telegraphic tenders or modification thereof will be entertained.
 - ii) Tender documents should be submitted along with duly filled in all Annexures. The tender will be divided in three parts:
 - a) Earnest money.
 - b) Technical and commercial bid
 - c) Price bid

The above three parts should be enclosed and SEALED SEPARATELY IN THREE ENVELOPES (for manual tendering only) as follows and all the three envelopes shall be super scribed with

- i) Name of Work
- ii) Tender No., and date,
- iii) Date of Opening of Tender
- iv) Name and complete address of the tenderer and
- v) All the said three envelopes should be submitted in one sealed cover by the tenderer super scribing above stated (i) to (iv) particulars.

Envelop No. 1:

Will contain Earnest Money of amount specified in NIT in the form of DD/ Banker's cheque in favour of NFL (respective unit/CO/Office), Payable at (respective unit/CO/Office). This envelope should be super scribed "EARNEST MONEY". If the party is seeking exemption of EMD under MSMED Act, it is required to submit the requisite documents showing eligibility in this envelop.

Envelop No. 2:

Second sealed envelope super scribed “TECHNICAL AND COMMERCIAL BID” containing the following documents:

Signed copies of complete tender documents, including Proforma for schedule of quantities WITHOUT prices as enclosed & documents as asked in Para 22 along with. Tenderer should sign each copy of these documents in token of acceptance of our terms and conditions.

Envelop No. 3:

Third sealed envelope super scribed, “PRICE BID – DO NOT OPEN” (in RED ink). This envelope should only contain the ‘Schedule of Quantities & Rates’/ ‘Price Bid’ with prices given in respective columns against each item, as enclosed herein, duly completed and signed & stamped on each page by the tenderer.

a) The price bid should be submitted clearly inscribing the name of the tenderer in the prescribed Proforma.

All the above three envelopes should be placed and submitted in a single envelope superscribed as “NIT No.: NFL/PT/M/A/13.442, Dated:21/05/2024

Date of Opening of the tender: **14/06/2024**

19. Opening of Tender:

The Tender shall be opened as under:

Envelope No. 1:

Super scribed ‘Earnest Money’ containing Earnest Money shall be opened first on the Scheduled Date & Time of opening of tenders in the presence of the Tenderers or their representative, who wish to be present at the time of Tender Opening.

Envelope No. 2:

Super scribed ‘Technical Bid’ will then be opened and discussion would be carried out with the respective Tenderers for clarifications, if any.

Envelope No. 3:

Super scribed ‘Price Bid’ will be opened if technical bid and EMD found in order on the same day or at a later date, which shall be intimated to the Tenderers.

20. The following documents have to be submitted with the offer in the envelope No. 2, failing which the tender will be liable for rejection:

(i) In case the parties are pre- qualified;

- a) Declaration Forms I, II & III (Annexure-II, III & IV)
- b) An Affidavit as per Annexure-VI on Non-Judicial Stamp paper of appropriate value
- c) Notarized/Certified copy Power of Attorney/ Authorization in name of person who has signed the tender documents/bid (in case of Partnership Firm/Company or otherwise as the case may be.

(ii) In case parties are not prequalified, their offer will be considered as per eligibility criteria mentioned in the NIT/Tender. Tenderer shall submit along with the tenders’ full particulars of their capacity, experience giving the list of similar jobs carried out by them during the last seven years, the complete address or organization for which such works have been executed and also substantiate their claims furnishing the copy of their credentials as per NIT. In the absence of these documents tender will not be considered

21. NFL reserves its right to open the Price bids of only such tenderers who are found to be meeting the eligibility criteria based on the documents submitted by him/them in the Technical bids.

22. Evaluation of offer shall be on overall L-1 basis.
23. All pages shall be initialed at the lower right-hand corner and signed wherever required in the tender papers by the tenderers or by a person holding power of attorney/ authorization authorizing him to sign on behalf of the tenderer before submission of tender. All corrections and alterations in the entries of tender paper will be signed in full by the tenderer with date. No eraser or overwriting is permissible.
24. No condition or deviation should be mentioned by tenderer in Price Bid. Price Bids with any condition or deviation shall liable to be rejected.
25. The prospective tenderer having any common Partner / Director / Managing Director etc. Or having any other common criteria shall be considered as sister / group / Associates Company. In such cases only one of them will be eligible for participating in the tender.
26. While submitting the offer, bidders may ensure that tender documents /offer have been signed by authorized signatory of the company. Subsequent withdrawal of offer / non-acceptance of orders placed based on the offer submitted by them will not be entertained on the ground that the offer was not signed by the authorized person.
27. One person will be allowed to represent only one company during discussion/negotiation with NFL. If same person is representing different companies with authorization letter from more than one company, such person will be allowed to represent only the first company called for negotiations.
28. NFL reserves the right to postpone the tender opening date and / or time and will intimate all the tenderers well in time, of such postponement along with notice of revised opening date and time.
29. In case, due to some unforeseen circumstances, the date of receiving / opening of the tender happen to be a holiday / closed day, the tender will be received / opened on the next working day.
30. More than one quotation in a single sealed envelope will not be considered. Not more than one tender shall be submitted by a tenderer or by a firm of tenderers. Further, more than one bid shall also include two or more bidders having common power of attorney holder. No two or more concerns in which an individual is interested as a proprietor and / or a partner shall tender for the execution of the same works. If they do so, all such tenders shall be liable to be rejected.
31. The tender is non-transferable. Unsigned tenders shall be out-rightly rejected.
32. NFL further reserves its right to accept / reject any / all tenders in whole or in part without assigning any reason thereof. Conditional tenders are liable to be rejected.
33. NFL shall not be responsible for delay, loss or non-receipt of tender document sent by post.
34. The personnel of the contractor shall not enter into any unlawful activity within the premises of NFL and have a good character.
35. In case the tender is received in open condition, then the entire risk for loss of confidentiality shall be with the party. NFL shall not be responsible on this account whatsoever.
36. The contractor shall not appoint any sub company / agency to carry out any obligation under the contract without prior written permission from NFL. If at any time such a discrepancy is detected, the contract shall stand terminated without any notice and the security deposit shall be forfeited.
37. The offers received after scheduled date and time of submitting the offer would be out rightly rejected.
38. If the tenderer(s) expire(s) after the submission of his / their tender or after the acceptance of his / their offer, NFL shall deem such tender cancelled. If a partner of a firm expires after the submission of their tender or after the acceptance of their tender, NFL shall deem such tender as cancelled, unless the firm retains its character.
39. NFL will have the right to issue addendum to tender documents to clarify, amend, modify, supplement or delete any of the conditions, clauses or items stated. Addendum so issued will form part of original invitation to tender.
40. If a tenderer resorts to any frivolous, malicious or baseless complaints / allegations with intent to hamper or delay the tendering process or resorts to canvassing/ rigging/ influencing the tendering process, NFL reserves the right to debar such tenderer from participation in the present / future tenders up to a period of 2 years.

41. Any revision, clarification, corrigendum, time extension, etc. to this Tender Document will be hosted on the above-mentioned website(s) only. Bidders are requested to visit the website regularly to keep themselves updated.
42. Throughout the Tender Documents, the terms 'Bid', 'Tender' & 'Offer' and their derivatives [Bidder/Tenderer, Bid/Tender/Offer etc.] are synonymous.
43. "Bidder shall not be affiliated with a firm or entity:
 - (a) That has provided consulting services related to the work to the NFL during the preparatory stages of the work or of the project of which the works/services form a part of. OR
 - (b) That has been hired (proposed to be hired) by the NFL as an Engineer/ Consultant for the contract."
44. Eligibility of any bidder from a country which shares a land border with India shall be dealt in accordance with the provisions mentioned in Annexure-XII.
45. The Bidder shall submit Power of Attorney/ Authorization in favour of the authorized signatory(s) of the Bid. In case of partnership firm, one or more of the partners of the firm or any other person (s) shall be designated as the authorized person (s) on behalf of the firm, who will be authorized by all the partners to act on behalf of the firm through a "Power of Attorney", specially authorizing him / them to submit & sign the tender, sign the agreement, receive payment, witness measurements, sign measurement books, make correspondences, compromise / settle / relinquish any claim (s) preferred by the firm, sign "No Claim Certificate", refer all or any dispute to arbitration and to take similar such action in respect of the said tender / contract. In case of Company, Notarized/Certified copy of Authorization/Power of Attorney (backed by the resolution of Board of Directors) in favour of the individual to sign the tender on behalf of the company and create liability against the company should be submitted. Such "Power of Attorney" should be stamped and authenticated by a Notary Public or by Magistrate and submitted along with the tender."
46. In case there is any change in status of the declaration prior to award of contract, the same has to be promptly informed to NFL by the bidder. It shall be the sole responsibility of the bidder to inform about their status on due date of submission of bid and during the course of finalization of the tender. Concealment of the facts shall tantamount to misrepresentation of facts and shall lead to action against such Bidders.
47. NFL reserves the right to verify all statements, information and documents submitted by the bidder in his tender offer, and the bidder shall, when so required by NFL, make available all such information, evidence and documents as may be necessary for such verification. Any such verification or lack of such verification, by NFL shall not relieve the bidder of its obligations or liabilities hereunder nor will it affect any rights of NFL thereunder."
48. These letter/instructions shall form part of the contract document and shall be signed and returned along with the tender documents.
49. The Tender shall be addressed to DGM (M&C), National Fertilizers Limited, Panipat Unit.

Thanking you,

Yours Sincerely,

For & on behalf of
National Fertilizers Limited

Name: _____

Designation: _____

Special Terms & Conditions of the Contract

Subject: Contract for Fabrication & erection of New Inter-connection Line (Suction, Extraction, Discharge, ARC By-pass Line, Balancing Line & Utility Lines) for installation of New BFW Pump at NFL, Panipat

1. **EMD:** Tenderer shall submit a EMD of Rs. 1,00,000/- in the manner as specified in clause No. 9 of GTC and in accordance with applicable government guidelines. Being works contract no benefit like exemption of EMD shall be available to MSME registered bidders. Bids without EMD shall be rejected.
2. **Validity of Contract:** The contract shall remain valid for a period of 12 months. The contract can be extended on the same rates, terms and conditions for a period of three months on sole discretion of NFL.
3. **Defect Liability Period:** The contractor shall give Guarantee certificate for a period of 06 months from the date of completion of work and clause No. 25 of GTC shall be applicable. All other General Terms & Conditions of NFL shall be applicable.
4. **Security Deposit:** The contractor shall deposit SD towards faithful performance of the contract. The Security Deposit together with EMD/Initial Security Deposit shall be 10% of the contract / Works order value excluding GST. Initial Security Deposit (ISD) shall be 2.5% of the Contract Work Order Value which is required to be deposited within 15 days of the issue of the Letter of Intent (LOI) /Work Order (WO) by the successful tenderer. EMD can be adjusted against SD.

The balance security deposit amount shall be recovered @ 7.5% from each running bill and the final bill so as to make the total security deposit at 10% of the Contract / Work Order Value. In case work is split between two or more parties, SD shall be submitted based on the value of split order.

No interest shall be paid on security deposit. Any amount recoverable from the contractor shall be deducted from RA bill/security deposit. Security deposit shall be returned to contractor after successful completion of the contract and obtaining "No objection certification" from executive department after expiry of Defect Liability Period.

The successful tenderer can furnish a Bank Guarantee from any of the scheduled bank excluding Gramin/Co-operative Bank in the form specified by NFL against Security Deposit / Performance Guarantee (as applicable) for the faithful and proper fulfilment of the contract. The Bank Guarantee should be valid for a period of 18 months (contract period plus defect liability period) plus 3 months claims period. The Bank guarantee should be submitted by Bankers directly to NFL in a sealed cover and not through contractor.

The Contractor shall also arrange a copy of swift message, for confirmation of BG (including all amendments) through SFMS mode, from the BG issuing bank generated on communication regarding issue of BG to our designated bank ICICI Bank Ltd, K1, Senior Mall, Sector-18, Noida, UP, 201301, IFSC Code ICIC0000031, as per following details:-

- (i). IFN 76 COV for issuance of bank guarantee
- (ii). IFN 767 COV for amendment of bank guarantee
- (iii). Issuing bank shall mention IFSC code as ICIC0000031 in field 7035 of IFN 76 COV/IFN 767 COV.

(iv). Issuing bank shall mention NFL beneficiary code as NFLNATIONAL04022015 in field 7037 of IFN760COV/IFN767COV

5. Completion period:

- a. **Pre-fabrication/Erection of Scaffolding:** Party to start pre-fabrication of pipeline and erection of scaffolding immediately after placement of work order. However, the pre-fabrication time will not be counted in 12 days' time as mentioned below.
 - b. **Final Hook up Activity:** i.e. connecting the new piping with existing headers, hydro testing/card board blasting shall be taken up during Annual Shut Down. Party will be given 12 days' time for complete the job including fabrication, erection & final hook-up/hydraulic testing.
 - c. Party will be given one Week mobilization period.
6. Rates are to be quoted strictly as per the schedule of rates in the NIT.
 7. Parties may see the jobs personally at site before quoting and may obtain necessary clarifications, if any.
 8. Boarding and lodging of party's man-power will be under contractor's scope
 9. All statutory obligations applicable in the state of Haryana and IBR shall have to be complied with.
 10. Contractor shall abide all the terms & conditions of GTC attached.
 11. The contractor shall be required to execute an agreement on Non-judicial Stamp paper of prescribed value within 15 days of receipt of Work order/LOI by him, as per prescribed NFL format.

12. TERMS OF PAYEMENT:

- a) Payment of full & final bill shall be released within 30 days or otherwise stipulated in the NIT/WO after receipt of bill completed in all respect. Payment of Security deposit deducted shall be released after completion of defect liability period on demand within 30 days. Payment to MSME Parties shall be made with in a period applicable as per MSMED Act or payment terms as per NIT/WO, whichever is earlier.
- b) The contractor has the option to receive payment through Electronic Funds Transfer (EFT)/RTGS Process. For this option, they may submit their bank particulars i.e. Customers Name, Name of the Bank, Bank Account No. (All digits in case of CBS branches),Place of branch, Branch Code (IFSC CODE-II digits) to enable NFL to release payment accordingly. All bank charges will be to their account.
- c) Contractor shall submit bill in triplicate to the Department along with measurement sheet duly verified by area in-charge. The area in-charge will forward the bill after verification to F&A Department for payment through HOD.
- d) NFL shall deduct TDS-Income Tax as per Income Tax Act, TDS/TCS-GST wherever applicable as per GST law, Commercial Tax, Cess including BOCW Cess at source from all payments due and to be made to the Contractor under this contract in accordance with provisions of relevant Act and Rules framed there under including any amendment and modifications thereof as applicable from time to time.
- e) The contractor shall furnish along with each running bill a certificate that he has complied with statutory provisions relating to Minimum Wages, PF & ESI and Contract Labour (R&A) Act, 1970 etc. and shall also submit copies of Wage Sheet, PF & ESI Challan(along with ECR and payment confirmation receipt).
- f) Bill should be signed by a person holding power of attorney or authorized representative of contractor.

g) In addition to above terms, payment of final bill will be made subject to, inter alia, following terms:

- i. Payment of final bill will be made to the contractor after submission of certificate from CISF Gate that all the gate passes issued to the labour of the contractor have been returned alternatively no objection certificate may be provided from CISF.
- ii. The Payment of final bill will not be made until the contractor has handed over the peaceful vacant possession of land, if any, handed over to him free from all encumbrances including offices, stores, workshop, temporary structure, lighting, fixture poles etc.
- iii. Return of empty packing material, scrap and unconsumed material issued by NFL.
- iv. The contractor shall be required to give a certificate along with final bill that he has made all payments towards wages as defined under the Payment of Wages Act, 1936 and Contract Labour (R&A) Act, 1970 and has also complied with other provisions of Labour Laws in respect of manpower engaged/employed for the execution of work.
- v. The contractor is further required to give an undertaking stating that in case any dispute arises on account of deployment of manpower/labour, contractor would be responsible to discharge the statutory obligations, if any, and NFL will stand indemnified against any such claim/demand made in future.
- vi. Following documents (as applicable) and documents to comply with statutory requirement shall be submitted along with the final bill after the successful execution of the job:
 - a. Undertaking for compliance of the labour laws in the prescribed format
 - b. No claim certificate in the format approved by NFL
 - c. No dues certificate form respective sections.
 - d. Self-attested copy of the ESI challan along with contribution history, separately for this contract.
 - e. Self-attested copy of the PF challan, Payment confirmation receipt, ECR with respect to PF deposit, separately for this contract.
 - f. Indemnity letter regarding statutory dues (PF, ESI, Minimum Wages, Labour Welfare Fund if applicable etc.) in the prescribed format
 - g. Self-attested copy of the wage sheet, attendance record, employee register and Loan/recovery in revised format of A,B,C&D.
 - h. Return of Gate passes issued by CISF / NOC from CISF

h) Payments to MSME Vendors

GoI has introduced electronic platform for facilitating the financing of trade receivables of MSMEs from buyers, through financiers, which is termed as Trade Receivables Discounting System (TReDS). NFL is already registered on RXIL TReDS platform.

MSME bidders are requested to kindly register on the TReDS platform and avail the TReDS facility, if they want to

The detail of RXIL contact person is as below:

Contact Name: Mr. Prajay Shukla

Contact No.: 8090051171

E-mail id: prajay.shukla@rxil.in

Bidders upon successful delivery shall submit their invoices along with the mandated enclosures including TReDS details. Upon receipt and acceptance of the supplied material/services and receipt of invoices with the mandated enclosures, NFL shall process the invoice for payment as per details submitted on TReDS platform. Any unfinanced invoice/s of MSME bidders seeking payment from NFL directly shall be processed as per the standard payment terms agreed in PO/contract.

All financing cost for using the facility shall be borne by the MSME bidder only

13. Applicability of GST:

- a. GST shall be paid extra. Clause 1.6.0 of GTC shall be applicable.
- b. TDS 2% shall be deducted as per provisionary under GST act in case taxable value of services/goods or both is more than ₹2.5 lakhs.

14. CONCILIATION & ARBITRATION:

(i) FOR INDIAN PARTIES

Any dispute or difference whatsoever arising between the parties out of or relating to the construction, meaning, scope, operation or effect of this contract or the validity or breach thereof shall be resolved amicably through negotiations by the parties. A "Notice of Dispute" shall be given by the party seeking resolution of a dispute to the other party. If the dispute is not resolved within Thirty (30) days from the notice, the dispute shall be referred to arbitration as per the procedure mentioned herein below:

A written notice shall be given by the contractor invoking arbitration to National Fertilizers Limited through Designated Authority (CMD / Functional Directors/ Unit Head), which may be specified as per contract value (Ref : CO Legal circular no. NFL/CO/Law/979 Dt. 02.03.2020)

Where the claim including determination of interest, if any, being claimed upto the date of commencement of arbitration does not exceed Rs. Five crore, the reference shall be made to a sole arbitrator. The parties shall mutually agree on the name of sole arbitrator. In case of disagreement upon the name of the sole arbitrator, the appointment of Sole Arbitrator shall be done in accordance with the provisions of Arbitration & Conciliation Act, 1996.

Where the claim including determination of interest, if any, being claimed upto the date of commencement of arbitration exceed Rs. Five crore, the reference shall be made to arbitral tribunal consisting of three arbitrators. Each party shall nominate one arbitrator each within 30 days from the date of receipt of notice of invocation of arbitration and two nominated arbitrators shall appoint the presiding arbitrator within 30 days thereafter. If a party to the dispute refuses or neglects to nominate an arbitrator on its behalf within the period specified, or the two arbitrators fails to nominate Presiding arbitrator, appointment of Arbitrator(s) shall be done in accordance with the provisions of Arbitration & Conciliation Act, 1996.

The Arbitration proceedings shall be governed by the Arbitration & Conciliation Act, 1996 and any further statutory modification or re-enactment thereof and the rules made thereunder.

It is agreed by and between the parties that in case a reference is made to the Arbitrator for the purpose of resolving the disputes/ differences arising out of the contract by and between the parties hereto, the Arbitrator shall not award interest on the awarded amount more than the rate of SBI PLR / Base Rate applicable to NFL on date of award of contract.

The Seat and venue of Arbitration shall be at Delhi/Place of respective Unit/Place of Zonal Office.

The cost of the proceedings shall be equally borne by the parties, unless otherwise directed by the arbitral tribunal. The decision of the arbitral tribunal shall be final and binding on all parties.

(iii) ARBITRATION FOR CPSES AND GOVERNMENT DEPARTMENT:

In the event of any dispute or difference relating to the interpretation and application of the provisions of commercial contract(s) between Central Public Sector Enterprises (CPSEs) / Port Trusts inter se and also between CPSEs and Government Departments / Organizations (excluding disputes relating to Income Tax, Customs & Excise Departments), such dispute or difference shall be taken by either party for resolution through AMRCD as mentioned in DPE OM No. 5/0003/2019-FTS-10937 dated 14TH December 2022 and decision of AMRCD on the said dispute will be binding on both the parties.

TECHNICAL SCOPE OF WORK

(A) GENERAL DESCRIPTION

In the Ammonia Plant at NFL Panipat, New BFW Pump with Motor is being installed at new Location. For Erection and Commissioning of New BFW Pump, Suction/Discharge/Extraction/ ARC By-Pass lines/ Balancing Line/ Utility lines of New BFW Pump is required to be connected to existing Headers.

(B) SCOPE OF WORK:

1. The Fabrication and Erection of new Interconnection lines for new BFW pump includes:
 - i. **Suction Line:** Connecting 10 inch Sch. 40 ASTM A106 Gr B line from suction of pump to existing 16 inch header as per Isometric drawing.
 - ii. **Extraction line:** Connecting 4 inch Sch. 80 ASTM A106 Gr B line from Intermediate stage of pump to existing 4 inch header as per Isometric drawing.
 - iii. **Discharge Line:** Connecting 8 inch Sch. 160 ASTM A106 Gr B line from discharge of pump to existing 12 inch header as per Isometric drawing
 - iv. **ARC By-pass lines:** Connecting 2.5 inch Sch. 160 and 6 inch Sch. 160 ASTM A106 Gr B line and 6 inch Sch. 160 ASTM A106 Gr B from ARC Bypass to existing 6 inch header as per Isometric drawing
 - v. **Balancing Line:** Connecting 2 & 3 inch Sch. 40/80 ASTM A106 Gr B line from pump balancing line to existing 3 inch header as per Isometric drawing.
 - vi. **Utility Lines:** Connecting Cooling water, Lube Oil lines etc. from nearest battery limit to new pump.

There may be some variation in number of joints based on actual site condition. Party shall carry out the same without any financial implications.

2. Prefabrication of piping as per convenient spools from pipes supplied in random commercial lengths. Contractor shall mark spools on isometrics and layout drawings in consultation with NFL.
3. Pipes in random length, pipe fittings, flanges, nut bolts etc. shall be supplied by the NFL as free issue material for fabrication of piping.
4. All piping shall be assorted and marked for identification to avoid mix up of different materials, as per color code provided by NFL.
5. Piping welding shall be done according to attached WPS. The Filler wire and Welding rod mentioned in WPS shall be arranged by Vendor.
6. Piping's root run and weld layers shall be done using TIG welding as per applicable WPS. Welding of socket joints for all high pressure piping shall be done by TIG welding only. Only Argon gas shall be used both for shielding and purging wherever required. After hydro-testing, all blanks, temporary spool pieces etc. shall be removed, replaced by permanent gaskets and fixtures, as required.
7. **Contractor will arrange for IBR Certified Welder for the job.** The contractor will submit copy of certification of the welder before start of job. Welders proposed to be deployed at SITE shall be tested for welding procedure qualification and welder performance qualification in the presence of NFL or his representative or any statutory authority whenever required strictly as per standards, codes and specifications.
8. The piping for new pump will required to be inter-connected to existing headers. For final of connections of piping from new pump to existing header, tie-in points from existing header will required to be taken. Cutting of existing piping along with removal of structure & supports for tie-in

points is to be done by grinder/plasma cutting only and is to be done after making fire enclosure. The obstructing structure & supports removed shall be installed back after final inter-connection of Piping.

9. Contractor shall carry out pre-heating & Stress relieving, 100% radiography and UT. And submission of films. Radiography camera, Radiography source, washing & developing facilities for radiographs shall be under contractor's scope. 100% Dye Penetrant Examination shall be done by contractor.

10. Completion period:

- a) **Pre-Fabrication/erection of Scaffolding:** Party to start pre-fabrication of pipeline and erection of scaffolding immediately after placement of work order. However the pre-fabrication time will not be counted in 12 days' time as mentioned below.
 - b) **Final hook up activity** i.e. connecting the new piping with existing headers, hydro testing/card board blasting shall be taken up during Annual Shut Down . Party will be given 12 days' time for complete the job including fabrication, erection & final hook-up/hydraulic testing.
 - c) Party will be given one Week mobilization period.
11. Fabrication of piping out of the pipes, flanges and fittings shall be supplied by the NFL as free issue material.
12. Erection of fabricated piping including those of all on-line items like orifice, tapings for flow, temperature and pressure instruments by welding, bolting as per drawing, specification, standards, codes and instructions of NFL. Orifice plates, control valves, piping spools may have to be removed and re-installed after hydro-test, cleaning & blowing of pipe lines, nothing extra shall be payable on this account.
13. Erection of piping after cleaning from inside and joining by bolting, welding etc. at site as per drawings, specifications/standards/codes and instruction of NFL.
14. Carry out dye penetrant examination, pre-heating, radiography, post weld heat treatment and submission of films and PWHT-charts. Pre-heating and Post weld heat treatment shall be done by electric heating only.
15. Modification of certain existing erected piping, if required as per site requirement by Dismantling and Reinstallation as per instruction of NFL.
16. **PIPING:** All activities listed below shall be covered under the scope of this CONTRACT. These activities shall be covered in the lump-sum rates for fabrication and erection of piping, nothing extra shall be paid on this account unless indicated otherwise specifically:-
- i. Cleaning, edge preparation, pre and post heating, welding as per applicable WPS, Non-Destructive Tests, wherever required as per specifications/standards and codes including supply of manpower, machinery, consumables and necessary arrangements for execution of all works.
 - ii. The Contractor shall be required to make stub-in connection for branches from main line for piping as well as instrument tapings. Stub-in connections shall include fabrication, installation and welding of reinforcement pads wherever required as per drawings, documents and standards. The fabrication and welding of these items shall also be in the scope of Contractor without any extra cost. However the pads and rings materials shall be made from free issue pipes/plates as per drawing, document, Standard, specifications and instruction of NFL.
 - iii. Cutting and beveling of special degree's elbow from standard 90 deg or 45 deg elbows, if required as per site requirement shall be made by Contractor as per drawing/specification and instruction of NFL.
 - iv. The piping shall be tested by welding an end blind plate prior to final welding with equipment/machinery. The thickness of such blind has to be calculated by the Contractor & got approved by NFL for fixing.

- v. Lapping shall be done on the machined seats of the mating surfaces of flanges prior to putting metallic ring gaskets.
- vi. There may be some deviations in equipment/machinery dimensions or levels and co-ordinates. This should be taken care of while prefabricating the piping. In shop fabrication as far as possible, margins for field adjustment in three planes shall be kept. Nothing extra shall be paid for cutting/welding etc. for such adjustments. It will be responsibility of the Contractor to verify the Isometrics by physical measurements prior to prefabrication of piping spool pieces. Contractor shall promptly inform any discrepancy in drawings to NFL. Nothing extra shall be payable for cutting, welding / or extra joints needed because of site adjustment.
- vii. The supply and application of anti-seize lubricating compounds such as MOLYKOTE, NEVER SIEZE, and GREASE etc. for the protection of threads of studs, bolts and nuts etc shall be in scope of contractor.
- viii. All permanent gaskets shall be fixed in the piping system just after all testing; blowing or pickling etc. operations are over, and just before leak testing / seal testing of the piping system.
- ix. During bad weather, the Contractor shall make suitable and adequate arrangement by way of providing protection against rain and wind for carrying out welding and other fabrication and erection jobs smoothly at SITE.
- x. In case of dissimilar thicknesses at any weld joint, the internal surface of thicker member shall be beveled for proper matching of I.D. The beveling slope shall not exceed 1:4. In such cases, for dissimilar thicknesses, no extra payment will be made.
- xi. Removal and re-erection of all on-line instruments during testing and/or calibration or functional testing, if so required, at SITE. Calibration and functional testing is excluded from the scope of this contract.
- xii. Carrying out hydraulic/pneumatic testing of the erected piping in loops after stress relieving, which shall be done only after the joints have been tested and found acceptable. Any temporary piping and temporary supports required for carrying out hydro testing shall be supplied and erected by the Contractor within his quoted rates, nothing extra is payable on this account. Existing piping or equipment may fall in the hydro test loops with the new piping. Contractor is required to carry out the test, tightening of bolts, and replacement of gaskets of existing system shall also be done without any extra cost to NFL. Making suitable arrangement for fixing of target plates shall be part of the scope of Contractor.
- xiii. After hydro testing, pipe lines shall be cleaned by air blowing and card board blasting or steam blowing, for efficient and proper cleaning of line as per instruction of NFL. During this activity, the piping shall be adequately supported. Temporary piping spool shall be fabricated by the Contractor from the materials taken from the NFL and erected as per site requirement. Fabrication and fixing/removal of all spool pieces, blinds etc. required for carrying out hydro-testing/blowing shall be Contractor's sole responsibility without any extra cost to NFL. For blowing and/or card board blasting existing piping system and equipment might have to be required to be taken in line. Nothing extra shall be payable on this account. For card board blasting, all materials shall be arranged by Contractor without any extra cost to NFL. Making suitable arrangement for fixing of target plates shall be part of the scope of Contractor.
- xiv. Carrying out the final "loop testing" of the entire process piping work including the erected equipment and machinery system with either air or Nitrogen at available pressure for establishing a leak proof system to the satisfaction of NFL. It shall be noted by Contractor that after hydro-testing till completion of loop testing, no additional payment shall be made for removal/fixing and re-fixing of permanent gaskets, fasteners, on-line instruments, etc.

17. **FABRICATION & ERECTION OF STRUCTURE & SUPPORTS:** The contractor is required to erect pipe structures in line with existing pipe rack/structure from standard beam ISMT 300/250 from ground level to approx. 10 meter height during laying of pipeline. The erection of such structure as required will be in contractors scope, however civil work required for the same will be provided by NFL. Structure material shall be provided by NFL.

Supports falling under the scope of this enquiry shall consist of:-

- a. Resting supports
 - b. Guide supports
 - c. Anchor supports
 - d. Axial stopper support
 - i) Fabrication of supports as per drawings, sketches, specifications, standards and instructions of NFL. Trunnion and Wrapper pad plates of Alloy Steel and Stainless Steel shall be fabricated by Contractor out of surplus scrap pipes available at site, in consultation with NFL. Fabrication of piping support shoes/clamps shall be done by Contractor as per support bill of materials outside the premises.
 - ii) Erection of all supports fabricated by Contractor. Spring Supports, to be supplied as free issue item to Contractor shall be erected by Contractor. Contractor may be required to fabricate and install additional supports, if required, up to the time of and including pre-commissioning.
18. Carrying out radiography, other non-destructive tests and stress relieving, as required at site.
19. Contractor shall agree to “Contractors Scope of Supply” and “General Instruction to Contractors”.
20. The contractor shall erect suitable steel scaffolding to execute the job and make fire enclosures where ever Gas-cutting/Welding job is involved.

(C) SCOPE OF SUPPLY BY NFL.

1. Air, Water, Power required for the job shall be supplied free of cost.
2. To allot a plot of land to enable the Contractor to build his office, stores, fabrication shop, urinal and latrine etc., at his own cost.
3. To issue hot and cold safety work permits to Contractor as and when required.
4. To facilitate issuance of gate-pass and night/special passes to workmen of Contractor for their entry to work SITE through security gate.
5. To facilitate issuance of gate-pass to the Contractor for entry of his materials and equipment including tools and tackles etc. for entry to work SITE through security gate.
6. Provide all clarifications in technical matters for expediting the job.
7. To lay down the system for issue of materials from NFL stores/storage yard.
8. To provide information regarding availability of fronts and materials to be issued by NFL so as to enable the Contractor to plan and organize the execution of work under his scope as per the overall project schedule.
9. To provide steam for steam-blowing and test media for leak/seal testing at available pressure.
10. To provide the following items as free issue to Contractor:
 - i) All permanent gaskets.
 - ii) All permanent fasteners, such as bolts/nuts/washers etc. for piping.
 - iii) Loose pipes (in standard/random lengths), pipe fittings, flanges, Valves spring supports etc.
 - iv) To provide piping layout drawings, piping isometric drawings, line list schedule, etc., which will be fabricated and erected at site.

11. Crane for shifting/erection of new pipes will be provided free of cost subject to availability. However, wherever it will be feasible to handle pipes with chain blocks the contractor will do the job with chain pulley blocks.

(D) SCOPE OF SUPPLY BY CONTRACTOR

The Contractor's obligations and responsibilities shall include but not limited to the following:

1. **Statutory approvals i.e. IBR as required during/after fabrication erection and commissioning shall be in scope of contractor including the required fees.**
2. Party shall make the proper scaffolding and platform for approach as required. The material required for scaffolding is to be arranged by party.
3. Hydraulic Pump for testing purpose.
4. To deploy skilled, semiskilled and unskilled personnel in requisite numbers and as per scheduled program so as to complete the WORK as per overall project schedule.
5. Contractor shall submit bar chart before start of job to NFL.
6. The job is to be executed strictly as per scope of work. In case scope of work is silent regarding any point the same is to be followed in accordance with ASME B31.3.
7. Covered shed area shall be made available by party for piping pre-fabrication and work shop without any extra cost to NFL. The pre-fabrication of piping shall not be allowed on loose earth. The Contractor must strictly adhere and built the same during the mobilization stage.
8. Contractor to report at Site within 07 days after placement of Work-order so as to make Gate Passes. Contractor shall initiate pre fabrication activities including Scaffolding erection, preparation of bevel edges/nozzle, fabrication of spool pieces required for execution of job so as to complete job within stipulated time.
9. Contractor to begin the pre-fabrication after the issue of WO as per instruction of NFL, so that pre fabrication activities including Scaffolding erection, preparation of bevel edges/nozzle, fabrication of spool pieces will be ready well before the ATA for final connections.
10. To deploy suitably qualified supervisors and engineers in requisite numbers to assure execution of good quality job as per best engineering practices and to the full satisfaction of NFL.
11. To maintain all the records for men, materials and execution of job as required by statutory law as well as NFL.
12. Since time is the essence of the job, party shall deploy sufficient skilled manpower for executing the work including riggers, IBR welders etc. so as to complete the final interconnection with existing header along with commissioning activities like hydro-testing/air blasting etc job is to be completed in 12 days time.
13. Party shall depute sufficient group including IBR welder required for carrying out welding of minimum two joints in parallel, each for day and night.
14. Contractor has to depute minimum two supervisors each for day and night shift to carry out job round the clock
15. All manpower, machinery, consumables and necessary arrangements for execution of all works shall be in the scope of contractor.
16. Pre Heating and PWHT will under party's scope. Preheating and PWHT shall be done by electric heating only and party to submit films and PWHT charts.
17. Radiography & UT shall be in scope of contractor.
18. 100% DPT will be under party's scope. However, NFL's NDT will check DP of random Joints. Contractor shall make arrangement for the same.
19. Radiography camera, Radiography source, washing & developing facilities for radiographs. To carry-out the radiography activities the Contractor shall fulfill the criteria as follows: -
 - The Contractor's NDT Engineers / Specialists must be fully qualified by the competent authority i.e. at least ASNT / ISNT Level II in UT, MPT, DPT, RT for carrying out statutory NDT inspection as per Rule 19 of SMPV (U) Rules 1981. The copy of certificates must be submitted to NFL for verification.

- The Contractor must have adequate qualified and experienced manpower to undertake the NDT jobs and should be capable to carry out the jobs on round the clock basis, if required.
 - The Contractor shall have adequate number of NDT equipment and all equipment must be calibrated and in good condition.
20. During bad weather, the Contractor shall make suitable and adequate arrangement by way of providing protection against rain and wind for carrying out welding and erection jobs smoothly at SITE.
 21. To submit documentation forming part of request for issue of completion certificate including IBR certification as applicable.
 22. Clear the site after cleaning the areas where the Contractor executed the job, stored the materials and built his office/fabrication shop etc.
 23. **Contractor will arrange for IBR Certified Welders for the job.** The contractor will submit copy of certification of the welder before start of job. Welder should also have done similar job on Sch 160 & above thickness piping. Welders proposed to be deployed at SITE shall also be tested in the presence of NFL or his representative or any statutory authority whenever required strictly as per standards, codes and specifications.
 24. Piping's root run for shall be done using TIG welding. Only Argon gas shall be used both for shielding and purging wherever required.
 25. All tools and tackles, Chain Pulley Blocks, Slings, D-shackles, scaffolding material, welding leads, welding machines /cutting set, grinders, jacks, fixtures etc. will be arranged by the party. Certificates of competent persons should be readily available whenever required by NFL.
 26. All safety appliances and PPEs like safety helmets, goggles, safety belts etc. required for safe execution of job as required by Safety Work Permit will be arranged by the party.
 27. The work should be carried out as per instructions of Engineer-in-charge and to be completed to the entire satisfaction of the Engineer-in-charge.
 28. All consumables like filler wires, welding electrodes, argon gas etc. shall be arranged by contractor.
 29. To arrange and supply all consumables (required for executing the job covered under the scope of Contractor such as but not limited to the following in adequate quantity of required quality and in time to meet the completion schedule :-
Electrodes & filler wires (strictly as per given WPS). Molykote, Rustolene, industrial gases such as oxygen, acetylene, argon, water soluble paper, diesel, petrol, kerosene, cotton waste, markine cloth, toil stones; emery papers; grinding wheel; cutting wheel; thread petroleum compounds, Teflon sealing tapes, raw dust, sponge, cardboard pickling and Passivation chemicals, Non-Asbestos fire resistant cloth and target plates etc.
 The make of welding electrodes and filler wires to be used by contractor are to be approved by NFL
 30. Contractor shall submit bar chart before start of job to NFL.
 31. In case of problem in X-Ray, contractor has to attend the joint on priority and the same has to be radiographed again.
 32. The following safety factor shall apply to all lifting equipment:
 - Hoisting line - 3.5
 - Guy wires - 3.0
 - Slings - 5.0
 - Shackles - 5.0
 - Safety factor - Breaking strength/load
 33. Contractor shall ensure that during the above ground welding job, Non-asbestos fire resistant cloth shall be used to cover instruments; cables etc., so as to avoid damage to these as well assure safe working conditions at lower levels.
 34. The Contractor shall make necessary arrangements for transportation to site and safe storage (storage room duly approved by BARC/DOSE) of radiographic source at site without any cost to NFL. However necessary space shall be provided by NFL.

35. In addition to safety regulations listed elsewhere in the NIT, NFL may issue certain safety directive which shall have to be followed meticulously without any reservation.
36. To arrange and supply all material, machineries, lifting, handling and shifting devices, tools and tackles which are required for the execution of jobs in sufficient quantities, as per the best engineering practices and within the targeted completion Schedule. It must be clearly understood that NFL shall not be responsible for arranging or supplying any material, tools and tackles. List of major tools and tackles required are as listed below:
- a) Motor generator welding sets in sufficient numbers
 - b) TIG welding sets complete with all accessories
 - c) Rectifier welding sets
 - d) Transformer sets for stress-relieving.
 - e) Gas cutting set along with flashback arrestors/Plasma Gas cutting set with applicable safety devices.
 - f) Drilling and grinding machines
 - g) Theodolite/Dumpy level /Master level/Sprit level
 - h) Wooden sleepers and scaffolding (metallic only) materials.
 - i) D-shackles, slings, lifting and spreader beams and any other special tools and tackles and facilities required to complete all jobs as per NIT to the engineering practices.
 - k) Central and portable electric ovens for electrode's baking & heating.
 - k) To arrange and supply in sufficient quantity of general spanners, special/ heavy duty /off set ring and D spanner, hydraulic/ pneumatic torque wrench etc. for tightening of piping/Equipments/Instruments flange connections.
37. The job is to be executed strictly as per scope of work. In case scope of work is silent regarding any point the same is to be followed in accordance with ASME B31.3/IBR.

38. **HYDROTESTING**

Hydraulic/Pneumatic testing as per codes/standards, specifications including repair, rectification and retesting of the complete piping system, by making suitable loops in consultation with NFL representative, shall be done by the Contractor. The decision to include any equipment in a loop or not shall be taken by NFL representative.

During testing all on-line instruments may have to be removed or blanked as required by NFL. If removed, necessary spool pieces are to be fabricated and installed by Contractor. The above instruments shall be installed back in the line only after cleaning and blowing of the line is over. Additional vents and drains, if required for pressure testing, shall be installed by Contractor. But the valves & pipes required for vents and drains shall be supplied by NFL as free issue. All the above activities form part of hydro-testing/ pneumatic testing, as the case may be. After hydro/pneumatic testing is completed to the satisfaction of the NFL representative, the piping shall be cleaned and blown with steam/air as per relevant technical specification. All on-line instruments shall be removed, (except if permitted by the NFL's representative) and installed back after cleaning of the pipe line. Whenever the on-line instruments are to be removed, supply, fabrication, installation and removal of spool pieces shall be arranged by the Contractor, without any extra cost to the NFL.

39. **CARD BOARD BLASTING**

The pipe lines which are required to be cleaned by air/card board blasting shall be done as per codes/standards, specifications and instruction of NFL in order to ensure that the lines are cleaned properly. For this purpose, the following points are kept in view:

- i) Lines to be card board blasted shall be properly supported.
- ii) One end of the line shall be blanked with two or three "standard card boards of 1/16" thickness & target plate" using flanges and bolting system.

- iii) Other end of the line shall be connected to the pneumatic pressure system.
 - iv) Air pressure shall then be increased till the card board bursts at around 3-4Kg/cm² pressure, thereby expelling out even the tiniest dust, rust and weld slag particles from inside of the pipelines.
 - v) Target plates are to be used here to check if the line is fully cleared.
 - vi) Supply of target plates and card-board shall be in the scope of Contractor
 - vii) The total loop shall be allowed to get heated up with suitable pressure steam for a certain interval after which steam should be vented and line allowed cooling. This alternative heating, cooling and venting shall enable proper cleaning of pipe line.
 - viii) After some cycles, target plates shall be installed to gauge the status of cleaning. Steam blowing shall continue till satisfactory results are obtained.
40. Consumables required for above work shall be in the scope of Contractor within his quoted rates.
 41. Cleaning/blowing of piping as per specifications and instructions of NFL.
 42. All piping, dismantled for hydro test, cleaning and blowing etc shall be re-erected in position as per drawings and instructions of NFL.
 43. Seal / leak testing of piping shall be done as per instructions of NFL.
 44. Removal of pre-set pins of spring hangers (after hydro-testing) and hot setting of springs.
 45. Contractor shall provide their services without any extra cost during start-up of plant for attending leakages, if found in new piping. Any leakage noticed, shall be attended by the contractor without causing any delay.
 46. All the scaffolding material, Personal protective & Safety Appliances like Safety Belts; Helmets etc. shall be arranged by the contractor.
 47. All the tools & tackles, cutting sets, welding sets etc. shall be arranged by the contractor.
 48. All consumables like welding electrode, filler wire, Oxygen, DA and Argon Gas shall be arranged by the contractor. The make of welding electrodes and filler wires to be used by contractor are to be approved by NFL.
 49. Contractor will shift all scrape to Scrap Yard.
 50. To undertake scope of work listed in this enquiry and to honor all other obligations listed specifically in other section or subsection of the enquiry.
 51. Reconciliation of materials issued to Contractor as directed by NFL.
 52. Handover of the completed works to NFL as per procedure laid down by NFL.
 53. To submit documentation forming part of request for issue of completion certificate.
 54. Clear the site after cleaning the areas where the Contractor executed the job, stored the materials and built his office/fabrication shop etc.

E) GENERAL INSTRUCTIONS TO CONTRACTOR

1. Edge preparation for all Welding shall be done by grinding.
2. All weld joint designs shall be deployed as per technical specifications. For alternative weld joint design, prior approval of NFL is required.
3. Maximum tolerance on line and level of steel work shall be ± 3 mm on any part of the structure. The structure shall not be out of plumb more than 3.5 mm on each 10 m section height and not more than 7 mm per 30M section height. This shall apply unless indicated otherwise on drawings.
4. The use of existing foundation, structures and supports as a point of anchorage for lifting, pulling and locking purpose is prohibited and shall be allowed only when NFL permits in writing.
5. At SITE, NFL representative shall have access at all times to all jobs being executed by the Contractor. The Contractor is bound by CONTRACT to provide him with all facilities, access to the jobs etc., in order to enable him to conduct inspection, checking, testing etc. as per his requirements. Regarding interpretation of drawings and technical documents, methodology in which jobs are

to be executed, modifications necessary to complete a job or jobs etc. and in all other SITE matters the decision of NFL representative shall be treated as final.

6. The Contractor shall arrange for daily cleaning of his SITE area of execution, including trenches, pits and drains, without fail. If he fails to do so, NFL shall arrange to carry out this job through any other agency and cost for this shall be deducted from the running bills of Contractor.
7. The Contractor shall take whatever steps are necessary so as not to exceed the allowable bearing capacity of the track when moving and or operating lifting equipments such as cranes, trailers etc.
8. Load test of all lifting tackles of Contractor shall be conducted by Contractor at SITE in the presence of NFL before such tackles are used at SITE.
9. Lapping shall be done on the mechanical seats of the mating flange surfaces prior to putting metallic ring gaskets wherever required.
10. Irrespective of the piping class, all welds of Pipes shall be made using TIG welding with Argon gas backing.
11. Quality control procedures and instructions for various supervisions in writing shall be prepared by the Contractor before opening their site. It shall be duty of quality control engineer to see that supervisors are following the same in Toto.
12. Equipment and structural shall be preserved after erection till Commissioning of plants as per instructions of NFL. Any damage and/or cost of rectification because on non-compliance of above shall be to Contractor's account. Even after handing over of the work to NFL if some defects, dirt and foreign materials are found inside the equipment, wrong fitting of any sort etc.; which could not be detected during the time of execution, were noticed; Contractor must make good the above mentioned defects; clean the inside of the equipment properly, arrange for proper fitting etc. at his own risk and cost, without any additional cost to NFL.
13. Consumables required for above work shall be in the scope of Contractor within his quoted rates.
14. Safety & security of contractors tool tackles, equipments etc in NFL premises is the responsibility of the contractor.

SCHEDULE OF RATES

Ref. No.: NFL/PT/M/A/13.442

SUB.: Fabrication & Erection of New Inter-connection Line (Suction, Discharge, ARC By-pass Line, Balancing Line & Utility Lines) for installation of New BFW Pump at NFL, Panipat

Sr. No.	Item description	UM	Qty.	Amount (excluding GST) (Rs.)		GST %	Amount (Rs.) Including GST	
				In Fig	In Words		In Fig	In Words
1	Lumpsum rate for Complete Fabrication & erection of Suction, Discharge, ARC By-pass Line, Balancing Line & Utility piping for commissioning of New BFW pump Unit as per Scope of work & NIT T&C's	Lump sum	1					

Date:

(Signature of Tenderer)

DECLARARTION FORM-I

(To be submitted in Envelope No. II)

Ref. No: NFL/PT/M/A/13.442

Dated: 21.05.2024

To,
Issuing Authority
National Fertilizers Ltd.
Panipat Unit

Subject: Tender No. NFL/PT/M/A/13.442 (Name of the contract) NIT for the contract for Fabrication & Erection of New Inter-connection Line (Suction, Extraction, Discharge, ARC By-pass Line, Balancing Line & Utility Lines) for installation of New BFW Pump at NFL, Panipat

I/We _____ have read the conditions of tender attached hereto and agree to abide by such conditions. I/We offer to do the job of “**Fabrication & Erection of New Inter-connection Line (Suction, Extraction, Discharge, ARC By-pass Line, Balancing Line & Utility Lines) for installation of New BFW Pump at NFL, Panipat**” work at the rates quoted in the attached Schedule of Rates and in accordance with the specifications, standards and instructions in writing of the Engineer-in-charge of M/s. National Fertilizers Limited and hereby bind myself/ourselves to complete the work schedule and progress of work.

I/We further agree to abide by the conditions of contract and to carry out all work within the specified time in accordance with specifications of materials and workmanship and instructions referred to in the Notice Inviting Tenders.

I / We agree to accept payment by ECS / EFT from your Bank. Details of my/our Bank A/c No. are as under:

Bank A/c No.:

Type Account (Current A/c or Saving A/c):

Name of the Bank:

Address of the Bank & Branch:

Branch Code:

IFSC Code

In case of acceptance of the tender by National Fertilizers Limited, I/We bind myself/ourselves to execute the contract as per the conditions mentioned in the tender documents, failing which, I/We shall have no objection or claim to the forfeiture of the Earnest Money deposited with National Fertilizers Limited, Panipat Unit.

Thanking you

Yours faithfully

For M/s _____

(Signature of Contractor/Tenderer with SEAL)

Address: _____

DECLARATION FORM-II

(To be kept in Envelope No. II)

The following declaration to be signed by Tenderer / Contractor and to be submitted along with required documents which would be duly self- certified:

Sr. No.	DESCRIPTION			
1	If a Tenderer has relation(s) whether by blood or otherwise with any of employee(s) of NFL (Owner), the Tenderer must disclose the relation at the time of submission of Tender. NFL shall reserve the right to reject the Tender or rescind the Contract, if such information is found incorrect.	YES/NO (If Yes, give the following details)		
		Name & Design. of the Employee	Place of Posting	Relation with the Employee
2	P.F. Registration No. of the firm / company to be indicated along with Documentary proof thereof.			
3	PAN No. (Permanent Account Number) of the firm / company issued by Income Tax Deptt. along-with Documentary Proof thereof.			
4	GST Registration No. of the firm / company issued by GST authorities along with Documentary Proof thereof.			
5	ESI Registration No. issued by ESI Authorities along-with documentary proof thereof.			
6	MSME Registration If the firm is registered as Micro/Small/Medium Enterprises as per MSMED Act, 2006, the same may be confirmed by the tenderer and submit a photocopy (Self certified) of the registration certificate of relevant services, in support thereof. Otherwise it will be construed that the firm is not registered as per MSMED Act, 2006.	Yes/ No (If Yes, a Self-certified copy of registration certificate to be submitted) Mention the category i.e. Micro/Small/Medium		

7	Type of Firm to be specified (Proprietor / Partnership / Limited Co. etc.)	
8	Name of the Firm	
9	Address of the Firm	
10	<u>Contact Details:</u> a) Name of the Person: b) Mobile number / Landline Number c) Email	<u>Contact Details:</u> a) b) c)
11	Power of Attorney/authorization for submission of tender document, as applicable Submitted	Yes / No
12	Tender cost amount, DD Number and Date	
13	EMD amount, DD Number and Date	

Note: Please attach separate sheets for the details, wherever necessary.

Signature of the Contractor/ Tenderer with SEAL

Place: _____

Dated: _____

DECLARATION FORM-III
(To be kept in Envelope No. II)

To,
Issuing Authority
National Fertilizers Ltd.
Panipat Unit

Subject: **NFL/PT/M/A/13.442, Dt. 21.05.2024** Name of the contract: **Fabrication & erection of New Inter-connection Line (Suction, Extraction, Discharge, ARC By-pass Line, Balancing Line & Utility Lines) for installation of New BFW Pump at NFL, Panipat**

Dear Sir,

1)	<p>UNDERTAKING</p> <p>a) I/We hereby confirm that Commercial Bid i.e. Price Bid is strictly as per Schedule of Quantities (Description/ Unit/Quantity of Items), Terms & Conditions and is also Un-conditional, including rebates offered. I/We shall have no objection for rejection of the offer, if found conditional.</p> <p>b) All the pages of NIT and GTC issued to us have been signed for its validity in token of its acceptance by us.</p> <p>c) It is confirmed that all the columns in the Price Bid, submitted in the Envelope-III, have been duly filled.</p> <p>d) I/We agree to evaluation of price bids and loading of GST under the terms of the NIT.</p>
2)	<p>ACCEPTANCE OF TENDER CONDITIONS</p> <p>I/We have personally read and gone through the scope of work, General Terms and Conditions of Contract (G.T.C.) and Special Terms and Conditions of NIT for the subject work, and I/we accept all the terms & conditions as mentioned in the G.T.C & NIT without any reservation and shall abide by the same.</p>
3)	<p>FOR DOWNLOADING THE TENDER DOCUMENT FROM WEBSITE</p> <p>With reference to your NIT No. NFL/PT/M/A/13.442 Dated _____ and the tender documents displayed on your web site, we hereby submit our tender for the subject work.</p> <p>Since we have not purchased the tender document from your office and the tender documents have been down-loaded by us from NFL website, we are hereby enclosing a demand draft No. _____ dated _____ of _____ (Bank) amounting to Rs. _____ (Rupees _____ only), in favour of National Fertilizers Limited, payable at Panipat towards the cost of tender documents.</p>
4)	<p>Labour License(If applicable)</p> <p>The contractor shall obtain Labour Licence, wherever applicable, from the appropriate Licensing Authorities i.e. Central/State Government under the Contract Labour (R&A) Act, 1970 & Contract Labour (R&A) Central Rules,1971 and submit a copy of the same to NFL, ----- before start of execution of contract work. Accordingly, we hereby give undertaking that:</p> <p>“As per provisions made under the Central Labour (R&A) Act 1970 & Contract Labour (R&A) Central Rules, 1971, we would obtain Labour License for the aforesaid</p>

	job of Fabrication & erection of New Inter-connection Line (Suction, Extraction, Discharge, ARC By-pass Line, Balancing Line & Utility Lines) for installation of New BFW Pump at NFL, Panipat from the appropriate Licensing Authorities i.e. Central/State Government, as applicable from time to time, and submit a copy of the same to NFL, ----- before start of execution of contract work”.
5)	I/We declare that the information and documents submitted along with the tender by me/us are correct and I/we are fully responsible for the correctness of the information and documents, submitted by us. It is further certified that I/We will not get myself/ourselves registered under more than one name
6)	I/We understand that in case of any information submitted by me/us is found to be false, forged or incorrect at any time during process for evaluation of tenders, it shall lead to forfeiture of the tender Earnest Money Deposit besides banning of business as per rules of NFL
7)	I/we also understand that if the certificates submitted by us are found to be false/forged or incorrect at any time after the award of the contract, it will lead to termination of the contract, along with forfeiture of EMD/SD and Performance guarantee besides any other action provided in the contract including banning of business as per rules of NFL

Thanking you

Yours faithfully

For & on behalf of Tenderer/Contractor
Signature of the Contractor/ Tenderer with SEAL

Place: _____

Dated: _____

REGISTRATION OF GST NUMBER

Requirement of GST Number:

The bidders are required to obtain the valid GST No., if applicable, as per laid down provisions under GST Act and submit a copy thereof as documentary evidence. Further in case the registration is not applicable under GST Act the same may be confirmed and following undertaking may be given by bidder.

UNDERTAKING

Whether Registration certificate obtained: **Yes/No** (Tick whichever is applicable)

- a. In case Yes, copy of valid certificate enclosed.
- b. In case No, It is confirmed that registration under GST Act is not applicable.
- c. In case registration under GST Act becomes applicable during the currency of contract, same shall be obtained and copy of valid GST No. shall be submitted to the NFL.

(Signature & stamp of bidder)

(To be kept in Envelope No. II)

(An Affidavit in original on Non-judicial Stamp Paper of appropriate value attested by Notary)

AFFIDAVIT

With reference to NIT No. NFL/PT/M/A/13.442, NIT Dated 21.05.2024 of National Fertilizers Ltd., for the work of Fabrication & Erection of New Inter-connection Line (Suction, Extraction, Discharge, ARC By-pass Line, Balancing Line & Utility Lines) for installation of New BFW Pump at NFL, Panipat. I, _____ S/o Sh. _____ R/o _____ do hereby solemnly affirm and declare as Proprietor / Partner / Authorized signatory of the firm on behalf of M/s _____ as under:

- a) That my / our firm / sister concern/their associates etc. has not been black listed, debarred, de-listed or put on holiday by any Institutional Agency / Government Department / Public Sector Undertaking for participating in the Tender, in last 3 years.
- b) No other Firm / Sister Concerns / Associates belonging to the same group are participating / submitting the Tender for this job.
- c) That information furnished by me / us in respect of the above tender is true and correct and nothing has been concealed. In case any of the information is found to be false and /or incorrect at any stage, NFL shall be at liberty to take the necessary action as deemed fit.

DEPONENT

Dated: _____

VERIFICATION

It is certified that the above contents / facts are correct and true to the best of my knowledge and belief and nothing has been concealed therein.

DEPONENT

Place _____

Date: _____

ELIGIBILITY CRITERIA

The bidders, in order to become eligible to participate in the bid, need to meet the following eligibility criteria and submit the self-certified documentary evidences in support thereof; failing which price bid shall not be opened.

Techno-Commercial Criteria

Sr. No	Eligibility Criteria	Supporting Documents Required
1)	<p>a) The bidder shall submit the status (i.e. Name and complete Address) of the firm/company along with its constitution such as Sole Proprietorship / Partnership Firm or Limited / Private Company, Year of Establishment and Place of Business, etc. and</p> <p>b) Affidavit as per Annexure-VI on Non-judicial paper in original and Power of Attorney / Authorization,</p>	<ul style="list-style-type: none"> ➤ In case of sole proprietorship, the bidder shall submit affidavit on Non-Judicial stamp paper of appropriate value in original, duly attested by notary regarding status / style of the business entity as per Annexure-XI ➤ Partnership firm shall submit a copy of Partnership Deed attested by notary ➤ Company shall submit a notarized /certified copy of Certificate of Registration / Incorporation and a copy of Articles of Association and Memorandum of Association ➤ Registered Society & Registered Trust shall submit certified copy of the Certificate of Registration and Deed of Formation/MOA. ➤ Affidavit in original ➤ The bidder shall submit Notarized/Certified copy of Power of Attorney on Non-Judicial stamp paper of appropriate value duly attested by Notary /Magistrate in case of Sole Proprietor / Partnership Firm/ Company or Authorization(backed by Board Resolution) in case of a Company in favour of a person who has signed the tender documents on behalf of tenderer / Firm / Company
2)	<p>a) The bidder should have valid Permanent Account Number (PAN), GST Registration No., PF Registration No. and ESI registration No.</p> <p>b) Declaration / Disclosure regarding any relation(s) with employees of NFL, Downloading of tender forms from NFL website etc.</p>	<p>The bidder shall submit Declaration I, II & III with self-attested copy of related documents wherever required like</p> <ol style="list-style-type: none"> I. PAN Card. II. GST registration certificate III. P.F Registration No. issued by PF Authorities. IV. ESI Registration No. issued by ESI Authorities, etc
3)	<p>The bidder should have successfully Completed “Similar Works” with performance and completion certificate, during the last seven years ending last day of previous month in which NIT has been issued.</p>	<p>The bidder shall submit a copy of Purchase/ Work Orders + Completion Certificate from the suppliers/contractor for at least one of the following</p> <p>a) Three similar completed works each costing not less than Rs 30,32,600/- including GST (With completion certificate)</p> <p>OR</p>

	<p><u>* Definition of Similar Work”</u></p> <p>Definition of Similar Work Given in Note B.1</p>	<p>b) Two similar completed works each costing not less than. Rs 37,90,750/- including GST (With completion certificate OR</p> <p>c) One similar completed work costing not less than Rs 60,65,200/- including GST (With completion certificate)</p> <p>Copies of Work orders in support of the above with full technical scope of work & commercial details including work order value along with the completion certificate from the concern organization indicating the contract period, executed value and date of completion.</p> <p>In case Completion certificate is not available, party shall submit the following:</p> <p>a. Self certificate mentioning that the party has successfully completed the submitted Work Orders, along with contact detail of end user.</p> <p>b. Copy of Invoice and payment receipt for above WOs.</p> <p>Note: Completed Similar works means award of WO and completion of same in stipulated period</p>
4)	Average Annual financial turnover of the bidder during the last 3 years ending 31st March 2023 should be at least Rs. 22,74,450/- including GST for one year	Bidder shall submit self-attested copies of Audited Balance Sheet and Profit & Loss A/c with UDIN of chartered Accountant for the last three financial on 31st March of the previous financial year (i.e. FY 2020-21, 21-22 & 22-23) <p>In case the bidder do not fall under the ambit of statutory audit and do not have audited annual reports/audited balance sheets and Profit & Loss statements, shall submit a statement indicating year wise turnover certified by Statutory Auditor/practicing Chartered accountant with UDIN</p>

NOTE :

- 1) In case of newly formed partnership firm, the credentials of individual partners from previous propriety firm(s) or dissolved previous partnership firm(s) or split previous partnership firm(s), shall be considered only to the extent of their share in previous entity on the date of dissolution / split and their share in newly formed partnership firm. For example, a partner A had 30% share in previous entity and his share in present partnership firm is 20%. In the present tender under consideration, the credentials of partner A will be considered to the extent of 0.3×0.2 *value of the work done in the previous entity. For this purpose, the tenderer

- shall submit along with his bid all the relevant documents which include copy of previous partnership deed(s), dissolution deed(s) and proof of surrender of PAN No. (s) in case of dissolution of partnership firm(s) etc.
- 2) In case of existing partnership firm, if any one or more partners quit the partnership firm, the credentials of remaining partnership firm shall be reworked out i.e., the quitting partner(s) shall take away his credentials to the extent of his share on the date of quitting the partnership firm (e.g. in a partnership firm of partners A, B & C having share 30%, 30% & 40% respectively and credentials of Rs 10 crore; in case partner C quits the firm, the credentials of this partnership firm shall remain as Rs 6 crore). For this purpose, the tenderer shall submit along with his bid all the relevant documents which include copy of previous partnership deed(s), dissolution deed(s) and proof of surrender of PAN No.(s) in case of dissolution of partnership firm(s) etc.
 - 3) In case of existing partnership firm if any other partner(s) joins the firm, the credentials of partnership firm shall get enhanced to the extent of credentials of newly added partner(s). on the same principles as mentioned in item 1 above. For this purpose, the tenderer shall submit along with his bid all the relevant documents which include copy of previous partnership deeds, dissolution/splitting deeds and proof of surrender of PAN No.(s) in case of dissolution of partnership firm etc.
 - 4) Any partner in a partnership firm cannot use or claim his credentials in any other firm without leaving the partnership firm i.e., In a partnership firm of A&B partners, A or B partner cannot use credentials of partnership firm of A&B partners in any other partnership firm or propriety firm without leaving partnership firm of A&B partners.
 - 5) In case a partner in a partnership firm is replaced due to succession as per succession law, the proportion of credentials of the previous partner will be passed on to the successor.
 - 6) If the percentage share among partners of a partnership firm is changed, but the partners remain the same, the credentials of the firm before such modification in the share will continue to be considered for the firm as it is without any change in their value. Further, in case a partner of partnership firm retires without taking away any credentials from the firm, the credentials of partnership firm shall remain the same as it is without any change in their value.
 - 7) In a partnership firm "AB" of A&B partners, in case A also works as propriety firm "P" or partner in some other partnership firm "AX", credentials of A in propriety firm "P" or in other partnership firm "AX" earned after the date of becoming a partner of the firm AB shall not be added in partnership firm AB.
 - 8) In case company A is merged with company B, then company B would get the credentials of company A also."

**Signature of the Tenderer /
Contractor with Seal**

B. Technical Criteria

B.1 Definition of similar work, shall be:

- a) Job involving fabrication and erection of Carbon steel Pipeline ASTM A106 Gr.B or higher grade involving welding by IBR certified welder, in minimum thickness of 23.0 mm, involving stress relieving in scope of party.

Note:

1. Bidder shall submit undertaking regarding deployment of sufficient skilled manpower with the experience and ability of working and material handling at height and all activities related to crane positioning. Bidder should have sufficient number of technical and skilled personnel for supervision and carrying out erection, fabrication and testing at site.
2. Bidder shall submit undertaking regarding deployment of NDT Engineers/specialist qualified by the competent authority i.e. atleast ASNT/ISNT Level-II in UT/MPT/DPT/RT for carrying out statutory NDT inspection as per rule 19 of SMPV (U) rules 1981 with experience and capability in various NDT examinations like DPT/RT/HT/UT at their own or through the agency having expertise in the respective job.

EVALUATION CRITERIA

1. The contract shall be awarded on Composite L – 1 basis. However, in case, it is found that L-1 tenderer has quoted non-workable rates for one / more items due to which they become L-1, NFL reserves the right to reject such tender. This condition shall be applicable on next lowest tender (s) also.
2. If the tenderer does not quote rate of any item, it may be noted that for evaluation purposes the same shall be taken based on the highest rate quoted by the other tenderers. However, order shall be placed for the same item based on the lowest rate quoted by the other tenderers. In that case, the party shall have to execute that item(s), failing which action shall be taken as per terms & conditions of the contract.
3. Tenderer are required to quote their rates of the respective item of work as per the “UNIT” of Item mentioned in the Schedule of Quantities. If it is found that the contractor has quoted his rates against a particular item(s) by changing the “UNIT”, the such quoted rates of the contractor with the changed “UNIT” shall be ignored and treated as UNQUOTED RATE against that particular Item(s) and the tender shall be evaluated as Para 2 above.
4. The revised bids on due date of opening of the tenders, as per NIT, shall not be entertained. Where for any reason the due date and / or time of opening the tender is extended, intimation regarding revised tender opening date and time shall be given / displayed on the website. In case any of the parties, who have submitted offer earlier, submits revised offer, within extended period, their revised offer only will be considered for opening. However, where techno-commercial negotiations are conducted with all the bidders to clarify the deviations vis-à-vis tender specifications/ requirements, which lead to changes in terms / conditions and / or technical specifications, the bidders shall be given a fair chance to revise their price bids accordingly.

However, revision in prices, if any, may be through Add-on/reduction on account of change in terms/conditions and/ or technical specifications w.r.t original price bid submitted by all the eligible before opening of original price bid. While evaluating the offer, the impact of add-on/reduction on the original price bid should be considered and no fresh revised price bid should be sought from bidders against the same tender.

5. If tenderer offers rebate unilaterally after due date and time of submission of tender/bids, it is not to be taken into account for evaluation purpose. But if that bidder/tenderer emerges as a lowest evaluated bidder/tenderer, the rebate so offered is to be taken into account for placement of order.
6. The rates should be quoted in words and figures. If some discrepancies are found between the rates given in the words and figures or the amount shown in the tender, the following procedure shall be followed:-
 - a) When there is difference between the rates in figures and words, the rates which correspond to the amount worked out by the tenderer shall be taken as correct.
 - b) When the rates quoted by the tenderer in figures and words, tallies but the amount is incorrect, the rate quoted by the tenderer shall be taken as correct.
 - c) When it is not possible to ascertain the correct rate in the manner prescribed above, the rate as quoted in words shall be adopted.

NATIONAL FERTILIZERS LIMITED

DEFINITIONS OF TERMS

In the contract documents herein defined where the context so admits, the following words and expression will have the meanings assigned to them respectively:

1. "The OWNER or NFL" means the NATIONAL FERTILIZERS LTD., incorporated in India, having its registered office at SCOPE COMPLEX, Core No-III, 7, Institutional Area, Lodhi Road, New Delhi-110003.
"Bid" (including the term 'tender', 'offer', 'quotation' or 'proposal' in certain contexts) means an offer to supply goods, services or execution of works made in accordance with the terms and conditions set out in a document inviting such offers.
"The Bidder" (including the terms "tenderer", "consultant" or "service provider") in certain context means any eligible person, firm or company, including a consortium (that is association of several persons, or firms or companies) participating in the procurement process with a procuring entity.
"Notice Inviting Tenders(NIT)" (including the term 'Invitation to bid' or 'request for proposals' in certain contexts) means a document and any amendment thereto published or notified by the procuring entity, which informs the potential bidders that it intends to procure goods, services and/ or works.
2. The "ENGINEER-IN-CHARGE" shall mean the person designated as such by NFL and shall include those who are expressly authorized by him to act for and on his behalf for operation of this contract.
3. The "WORK" shall mean the works to be executed in accordance with the contract or part thereof as the case may be and shall include all extra, additional, altered or substituted works as required for purpose of the contract.
4. "CONSTRUCTION EQUIPMENT" means all appliances and equipment of whatsoever nature for the use in or for the execution, completion operation or maintenance of the work unless intended to form part of permanent work.
5. "SITE" means the areas in which the work is to be performed by the Contractor and shall include a part or portion of the site on which the permanent work is proposed to be constructed.
6. The "TENDER DOCUMENTS" shall consist of Short Tender Notice, General Instructions to the Tender, General Conditions of Contract, Special Conditions of Contract, Specifications, Drawings, Time Schedule Tender Form, Performa or Agreement Form Schedule of Rates, and Addendum/Addenda to Tender Documents.
7. "THE CONTRACTOR" means any person or persons or firm or company whose Tender has been accepted by NFL with the concurrence of the Owner, and the legal personal representatives, successors and permitted assigns of such person, persons firm or company. Contractor includes "Service Provider or Consultant" also.
8. The "CONTRACT" shall mean the Agreement between NFL and the Contractor for the execution of the works including therein all contract documents.
9. The "SPECIFICATIONS" shall mean the various Technical specifications attached and referred to in the Tender documents. It shall also include the latest addition of relevant Indian Standard Specifications published before entering into contract.

10. "The DRAWINGS" shall include Maps, Plans and Tracings OR Prints thereof with any modifications approved, in writing by the Engineer-in-charge and such other drawings as may, from time to time, be furnished or approved in writing by the Engineer-in-charge.
11. The "CONTRACT DOCUMENTS" shall consist of Agreement, Tender documents as defined in Clause 6, 7 & 8 above, Acceptance of Tender and further amendments.
12. The "ALTERATION ORDER" means an order given in writing by the Engineer-in-charge to affect additions to or deletion from and alterations in the works.
13. The "COMPLETION CERTIFICATE" shall mean the Certificate to be issued by the Engineer-in-charge when the works have been completed to his satisfaction.
14. The "FINAL CERTIFICATE" in relation to a work means the Certificate issued by the Owner after the period of liability is over.
15. The "PERIOD OF LIABILITY" in relation to work means the specified period from the date of issue of Completion Certificate upto the date of issue of Final Certificate during which the Contractor stand responsible for rectifying all defects that may appear in the works.
16. "ZERO DATE" shall mean the date of issue of LETTER OF INTENT (LOI) or issue of WORK ORDER, whichever is earlier or as mentioned in work order.
17. "GTC/GTCC" means General Terms & Conditions of Contract. "STC" shall mean Special Terms and Conditions of the contract.
18. Technical Terms and Conditions & Special Terms and conditions are succeeding to GTC. In case of any discrepancy or inconsistency between technical terms and conditions, special terms and conditions and general terms and conditions, the following order of preference shall be followed:
 - a) Scope of Work /Technical Terms and Conditions
 - b) Special Terms and Conditions
 - c) General Terms and Conditions (GTC/GTCC)
19. "Bid security" (including the term 'Earnest Money Deposit'(EMD), in certain contexts) means a security from a bidder securing obligations resulting from a prospective contract award with the intention to avoid: the withdrawal or modification of an offer within the validity of the bid, after the deadline for submission of such documents; failure to sign the contract or failure to provide the required security for the performance of the contract after an offer has been accepted; or failure to comply with any other condition precedent to signing the contract specified in the solicitation documents
20. "Class-I local supplier" means a supplier or service provider, whose goods, services or works offered for procurement, meet the minimum local content as prescribed for 'Class-I local supplier' under the Public Procurement (Preference to Make in India), Order 20171;
21. "Class-II local supplier" means a supplier or service provider, whose goods, services or works offered for procurement, meets the minimum local content as prescribed for 'Class-II local supplier' but less than that prescribed for 'Class-I local supplier' under the Public Procurement (Preference to Make in India), Order 20172;
22. "Competent Authority" means the officer (s) who have been delegated the financial powers to approve the decision.
23. "e-Procurement" means the use of information and communication technology (specially the internet) by the procuring entity in conducting its procurement processes with bidders for the acquisition of goods (supplies), works and services with the aim of open, non-discriminatory and efficient procurement through transparent procedures;
24. "Enlistment" means including the name of the contractor in the list of after verification of credentials.

25. "Goods" includes all articles, material, commodity, livestock, furniture, fixtures, raw material, spares, instruments, machinery, equipment, industrial plant, vehicles, aircrafts, ships, medicines, railway rolling stock, assemblies, sub-assemblies, accessories, a group of machineries comprising an integrated production process or such other categories of goods or intangible products like software, technology transfer, licenses, patents or other intellectual properties purchased or otherwise acquired for the use of Government but excludes books, publications, periodicals, etc., for a library. The term 'goods' also includes works and services which are incidental or consequential to the supply of such goods, such as, transportation, insurance, installation, commissioning, training and maintenance.
26. "Invitation to (pre-)qualify" means a document including any amendment thereto published by the procuring entity inviting offers for pre-qualification from prospective bidders;
27. "Invitation to Enlist" means a document including any amendment thereto published by the procuring entity inviting offers for bidder enlistment from prospective bidders;
28. "Local Content" means the amount of value added in India which shall, unless otherwise prescribed by the Nodal Ministry, be the total value of the item procured (excluding net domestic indirect taxes) minus the value of imported content in the item (including all customs duties) as a proportion of the total value, in percent.
29. "Non-Local supplier" means a supplier or service provider, whose goods, services or works offered for procurement, has local content less than that prescribed for 'Class-II local supplier' under the Public Procurement (Preference to Make in India), Order 20174.
30. "Pre-qualification (bidding) procedure" means the procedure set out to identify, prior to inviting bids or along with tender, the bidders that are qualified to participate in the procurement;
31. "Pre-qualification document" means the document including any amendment thereto issued by a procuring entity, which sets out the terms and conditions of the pre-qualification bidding and includes the invitation to pre-qualify;
32. "(Public) Procurement Guidelines" means guidelines applicable to Public Procurement, consisting of under relevant context a set of- i) Statutory Provisions (The Constitution of India; Indian Contract Act, 1872; Sales of Goods Act, 1930; and other laws as relevant to the context); ii) Rules & Regulations (General Financial Rules, 2017; Delegation of Financial Power Rules and any other regulation so declared by the Government); iii) Manuals of Policies and Procedures for Procurement (of Goods; Works; Consultancy/ other services or any for other category) promulgated by the Ministry of Finance and iv) Procuring Entity's Documents relevant to the context (Codes, Manuals and Standard/ Model Bidding Documents);
33. "Procurement process" means the process of procurement extending from the assessment of need; issue of invitation to pre-qualify or to enlist or to bid, as the case may be; the award of the procurement contract; execution of contract till closure of the contract;
34. "Procuring Entity" (including Procuring Authority or Employer) means any Ministry or Department of the Central Government or a unit thereof or its attached or subordinate office to which powers of procurement have been delegated;
35. "Prospective bidder" means anyone likely or desirous to be a bidder;
36. "Reverse auction" (or the term 'Electronic reverse auction' in certain contexts) means an online real-time purchasing technique utilized by the procuring entity to select the successful bid, which involves presentation by bidders of successively more favorable bids during a scheduled period of time and automatic evaluation of bids;
37. "service" is defined by exception as any subject matter of procurement other than goods or works, except those incidental or consequential to the service, and includes physical, maintenance, professional, intellectual, training, consultancy and advisory services or any other service classified

or declared as such by a procuring entity but does not include appointment of an individual made under any law, rules, regulations or order issued in this behalf. It includes 'Consultancy Services' and 'Other (Non-consultancy) Services';

38. "Subject matter of procurement" means any item of procurement whether in the form of goods, services or works or a combination thereof;
39. "Works" refer to any activity, sufficient in itself to fulfill an economic or technical function, involving construction, fabrication, repair, overhaul, renovation, decoration, installation, erection, excavation, dredging, and so on, which make use of a combination of one or more of engineering design, architectural design, material and technology, labour, machinery and equipment. Supply of some materials or certain services may be incidental or consequential to and part of such works. The term "Works" includes (i) civil works for the purposes of roads, railway, airports, shipping-ports, bridges, buildings, irrigation systems, water supply, sewerage facilities, dams, tunnels and earthworks; and so on, and (ii) mechanical and electrical works involving fabrication, installation, erection, repair and maintenance of a mechanical or electrical nature relating to machinery and plants.

GENERAL TERMS & CONDITIONS (GTC/GTCC)

1.0 The execution of the work may entail working in all the site and weather condition and no extra rate will be considered on this account. The contractor may have to carry out the jobs to work round the clock as per our requirement to be decided by Engineer in- charge and the Contractor should take this aspect into consideration for formulating his rates and quotation. No extra claim/overtime will be paid on this account.

2.0 Electricity, Water and Service Air will be provided free of cost at one point as per requirement of the job. All lifting tools & tackles are to be got tested under the Competent Person engaged by State Government from time to time and the certificates duly verified by Competent Authority are to be submitted to the Department before taking up the job.

3.0 Suitable accommodation will be provided for the contractor or his authorized representative on chargeable basis, if available, NFL may allot land for putting temporary Godown/ workshop for making storage, work site by the contractor, free of cost.

4.0 The contractor shall have to make his own arrangements for all Tools & Tackles, Skilled and Unskilled labours etc. required for the job. The work is subject to inspection at all time by the Engineers-in-charge and the Contractor shall have to carry out the work to the entire satisfaction of the Engineer-in- charge.

5.0 Sub-Contracting of the job will not be allowed without prior written permission of the owner (NFL). If sub-contracting is allowed by Owner in full or part, the contractor shall be solely responsible for paying each Sub-Contractor and any other person to whom any amount is due from Contractor for services, materials or supplies otherwise related to the Work. Contractor shall take all reasonable steps and actions to ensure that such services have been or will be properly performed.

Owner shall not be deemed by virtue of the Contract to have any contractual obligation to or relationship with any Sub Contractor. The responsibility of successful completion of work by sub-contractor shall lie with Contractor. Sub- contracting will in no way relieve the Contractor to execute the work as per terms of the Contract.

6.0 PAYMENT OF TAXES AND DUTIES

6.1 The rates to be quoted by the tenderer should be inclusive of all applicable taxes, duties, levies etc. but excluding GST. Statutory deductions on account of Income Tax at source, at the applicable rates of the Gross Value of the Bill shall be made from the Contractor's monthly bills for depositing the same with respective Statutory Authorities as per the provision of the respective Acts and guidelines issued by Govt. of India. No request for increase / decrease or inclusion of any tax shall be entertained afterwards.

6.2 The rates quoted for materials should be on F.O.R. basis and are inclusive of all taxes. No GST will be paid as extra.

6.3 Addition / deletion of taxes imposed by the State Governments / Central Government after submission of tender documents and during contractual period shall be to NFL's account. Any subsequent change in the rate of GST shall be to NFL's account during contractual period only.

6.4. The Total Contract Value shall be inclusive of all applicable taxes, duties, levies etc. except GST.

- a) The successful tenderer who is liable to be registered under CGST/IGST/UTGST/SGST Act shall submit GSTIN along with other details required under CGST/IGST/UTGST/SGST Act to NFL immediately after the award of contract, without which no payment shall be released to the contractor. The contractor shall be responsible for deposit of applicable GST to the concerned authority.
- b) NFL shall pay GST as per provisions of GST Act. To remain competitive, bidders are advised to work out their rates excluding the impact of taxes paid on the input materials to be used in execution of contract as the same shall be set off in the form of input tax credit against GST.
- c) Party shall issue the taxable invoice in the manner prescribed under the GST Act within 30 days from the date of successful completion of job/contract in case of full & final payment against 1st & final bill and within 30 days of billing period in case of annual rate contracts having provision for monthly R/A bills. In case of any difference between the taxable/assessable value / or tax charged in the tax invoice is found the contractor shall issue credit/debit note as the case may be in the manner specified in the Act, failing which NFL may withhold the payment till the rectification of such difference. Up loading of taxable invoice and credit/debit note shall be done by the contractor strictly within the period prescribed in GST Act.
- d) In the event input tax credit of the GST charged by the contractor is denied by the tax authorities to NFL, then NFL shall be entitled to recover such amount from the contractor by way of adjustment from the next invoice/Security Deposit. In addition, to the amount of GST, NFL shall also be entitled to recover interest and penalty, in case it is imposed by the tax authorities on NFL.

6.5. Liability of NFL shall be restricted to the amount of GST only, and any interest/ penalty etc. shall be to the contractor's account.

6.6. Nature of Contract and Applicable GST Rates: Rates & Guidelines shall be applicable as notified by the Central Govt. from time to time.

6.7. As per GST, the liability towards payment of GST lies with the service provider, so NFL is not responsible for any non-compliance of the GST Law by the tenderer. However, in case of services notified for liability of payment of GST, under Reverse Charge Mechanism, on the part of service receiver, the Company (NFL) shall comply with the same as the service receiver.

7.0 The rates quoted by the tenderer will be firm for the currency of the contract period including extension if any and will not be subjected to escalation irrespective of any increase what so ever, except where escalation clause is specifically mentioned in the tender document.

8.0 All Statutory Provision shall be followed and applicable even if occurred after placement of W.O. but did not exit at the time of Tender. However additional statutory implication levied by State

/ Central Govt after last date of submission bid shall be to NFL account and shall be reimbursed on submission of proof of payment by the Contractor

9.0 The Tenderer should make a deposit of Earnest Money and Tender Fees as per Tender Documents by an A/C Payees Demand Draft, drawn on any Scheduled Bank except Rural or Co-Operative Bank in favour of "National Fertilizers Limited, Bathinda/Nangal/Panipat/Vijaipur Unit " payable at Bathinda/Nangal/Panipat/Vijaipur /Noida or through payment link provided on our website (www.nationalfertilizers.com) and details to be indicated in Tender document which is to be submitted in Envelop-I. The Earnest Money and Tender Fees shall not be accepted in any other form except as specified. Earnest Money and Tender Fees should accompany the Tender in separate Envelope without which tender will not be opened and it will be considered as rejected. The EMD may be forfeited and appropriated by NFL without prejudice to any other right or remedy to NFL under the following conditions:

- a) If a Bidder withdraws his Bid during the validity or agreed extension of validity period duly agreed by the bidder.
- b) If the bid is varied or modified in a manner not acceptable to the NFL during the validity or agreed extension validity period duly agreed by the bidder.
- c) In the case of a successful Bidder, if the bidder fails to commence the work awarded to him or sign the Contract agreement.
- d) In the case of a successful Bidder fails to furnish Security Deposit/Performance Guarantee.
- e) If bidder is delisted/debarred or blacklisted by NFL.

The failed Contractor/tenderer, for the reasons as stated above shall be debarred from participating in the re-tender for that work.

9.1 Bid Validity:

The bid should be kept valid for acceptance for a period of 120 (one hundred twenty) days from the date of opening of tender/Technical Bid. A bid valid for shorter period may be rejected by the Owner as being non-responsive.

Under the exceptional circumstances, prior to expiry of the original Bid validity period, the Owner may request the Bidder for a specified extension in the period of validity. The request and the responses thereto shall be made in writing or by E-mail.

In the event of Owner seeking extension of period of validity of the Bids, the validity of EMD shall also be suitably extended.

A Bidder agreeing to the request of Owner seeking extension will not be required nor permitted to modify his bid, and will be required to extend the validity of his EMD correspondingly.

10.0 The following tenders will be liable to be rejected:

- a) Tenders submitted by Tenderer who resort to canvassing.
- b) Tenders, which do not fulfil any of the conditions, laid down in the Tender Documents or are incomplete, in any respect.

- c) Tender, which contain uncalled for remarks or any alternative additional conditions.
- d) Offer received after schedule date & time of submitting the offer would be out rightly rejected.

10.1 The company reserve the right to accept the lowest or any other Tender in part or in full or award parallel contracts or reject all OR any of the Tender without assigning any reasons.

11.0 If the tenderer has relations whether by blood or otherwise with any of the employees of the NFL, the tenderer must disclose the relation in the Form of Declaration attached, at the time of submission of tender failing which NFL shall reserve the right to reject the tender or rescind the Contract. It shall also be certified by the tenderer that none of NFL's ex-employee is employed with them. (In case any ex-employee of NFL is employed, furnish details separately).

12.0 The contractor may employ such employees/ labours as he may think fit and the employees so employed should be employees of contractor for all purposes whatsoever and shall not be deemed to be in the employment of NFL for any purpose whatsoever. The contractor shall abide by all rules, laws and regulations that may be in force from time to time regarding the employment or conditions of service of the employees. If under any circumstances whatsoever, NFL is held responsible in any manner whatsoever for the default or omission on the part of the Contractor in abiding by the aforesaid rules, regulations and laws or held liable or responsible to the employees of the contractor in respect of any matter whatsoever and called upon to make payments on that account, NFL shall be reimbursed by the contractor for the same as also any other expenses costs and charges incurred by NFL in any proceeding or litigation arising out of any claim, demand or act on the part of the employees of the contractor, NFL shall be entitled to claim, demand or compensation from the contractor in that event. NFL shall also be entitled to recover the aforesaid amount from the Contractor that may become due and payable to Contractor.

13.0 Interested tenderer after studying the tender documents carefully, may obtain necessary clarifications, if any in writing before tendering, submitting of tender implies that the Tenderer has obtained all the clarifications required. No claim on ground for want of knowledge in any respect will be entertained. No claim for extra charge consequent on any misunderstanding or otherwise will be allowed.

14.0 The Contractor shall be liable to the company for any omission or Commission on his part or on the part of his employees thereby causing any loss, damage or inconvenience to the company.

15.0 The Contractor shall make his own arrangement for removal of old as well as unused material, including packing materials and empty cases free of cost from work site to the place indicated by the Engineer-in-charge after completion of work and nothing extra will be paid.

16.0 The decision of Engineer-in-charge in regard to all matters relating to the Tender and for determine the category of work with reference to material of an item not mentioned in scope of work shall be final.

17.0 QUANTUM OF JOB: Estimated value of work has been worked out on technical assessment / on the basis of job executed in past. NFL will not give any guarantee for minimum billing, minimum quantum of work during the period / currency of the contract.

18.0 RISK AND COST: If the Contractor is unable to execute the work any loss incurred by the company in this respect, will be, to the Contractor's account. The company may also terminate the contract

after giving a notice, if in its opinion; the work under the contract is not being done to its satisfaction. The Company will also have right to get the job done by a third party at the risk and cost of the Contractor till the expiry of the period of the contract and debit the cost plus 25% + applicable GST to the Contractor.

19.0 VALIDITY OF THE CONTRACT- The Contract shall remain valid for a period as specified in STC/NIT reckoned from the date of its award. The job can therefore, be got done any time during the tenure of the contract. Normally Notice to 7 days be given for starting the job but the Contractor should be able to mobilize within 24 hours, if the necessity so arises.

20.0 FORCE MAJEURE: - The terms and conditions agreed upon under the contract shall be subject to Force Majeure. Neither the contractor nor NFL shall be considered in default in the performance of their obligation contained therein, if such performance is prevented or delayed or restricted or interfered with by reason of War, Hostilities, Acts of Public Enemy, Civil Commotion, Strike, Lockouts, Epidemics/Pandemics, Accidents, Fires, Explosions, Flood, Earthquake, regulation or ordinance or requirement of any Government or any sub-division thereof or authority or representative of any such Govt., and/or due to technical snag/reasons or any other Act whatsoever, whether similar or dissimilar to those enumerated beyond the reasonable control of the parties hereto or because of any act of GOD. The party so affected, upon giving prompt notice to other party of such conditions and cause thereof from within 15(Fifteen) days of occurrence of such event, shall be excused from such performance to the extent of such prevention, delay, restriction or interference for the period it persists provided that the party so affected shall use its best efforts to avoid or remove such causes of non- performance if possible and shall continue performance hereunder with the utmost dispatch whenever such causes are removed.

If the performance in whole or in part of any obligation under this contract is prevented or delayed by reason of any such event for a period exceeding 90 (Ninety) days, either party may at its option terminate the contract by giving notice to the other party.

For delays arising out of Force Majeure neither NFL nor the Contractor shall be liable to pay extra costs or to make good any losses incurred consequent to the happening of any of the event, provided it is mutually established that Force Majeure condition did actually exist.

21.0 LOSS TO PLANT DURING EXECUTION: Any damage or loss caused to plant Equipment etc. during execution of this contract will be made good by the contractor at his own cost and risk.

22.0 NFL shall have power to make any alteration in, omission from, addition to, or substitutions for original Specifications and instructions which may be considered necessary, during the progress of work and Contractor shall have to carry out the work in accordance with any instruction which may be given to him in writing duly signed by Engineer-in-charge. Such alteration, omission, additions, substitutions, shall not invalidate the contract and any altered, additional or substituted work which the Contractor may be directed to do in the manner above specified as a part of the work, shall be carried out by the Contractor on the same condition in all respects on which he has agreed to do the main work.

23.If the rate for the additional altered or substituted work are specified in the contract for the work. The Contractor is bound to carry out the additional, altered or substituted work at the same rate as per specifications in the rate contract for that work.

- a) In the event the extra or substituted items of the work does not fall in category as above, the cost will be calculated on the basis of actual labour and consumable materials utilized for the job. The quoted rates will be inclusive of overhead and profit. The quantum of labour and consumable material used will be assessed by the Engineer-in-charge, whose decision in this respect will be final and binding upon the Contractor. The contractor will be required to obtain prior approval of NFL for rates payable to him for such extra items.
- b) In case, the Contractor fails to do the extra and/or substituted work. NFL will have the option to get the work done through another agency at the Contractors' risk and cost.

24. SECURITY: The contractor shall deposit SD towards faithful performance of the contract.

The Security Deposit together with EMD/Initial Security Deposit shall be 10% of the contract / Works order value excluding taxes. Initial Security Deposit (ISD) shall be 2.5% of the Contract Work Order Value excluding taxes which is required to be deposited within 15 days of the issue of the Letter of Intent (LOI) /Work Order (WO) by the successful tenderer. EMD can be adjusted against SD. The balance security deposit amount shall be recovered @ 7.5% from each running bill and the final bill so as to make the total security deposit at 10% of the Contract/ Work Order Value excluding taxes. In case work is split between two or more parties, SD shall be submitted based on the value of split order.

No interest shall be paid on security deposit. Any amount recoverable from the contractor shall be deducted from RA bill/security deposit. Security deposit shall be returned to contractor after successful completion of the contract and obtaining "No objection certification" from executive department after expiry of Defect Liability Period.

The successful tenderer can furnish a Bank Guarantee from any of the scheduled bank excluding Gramin / Co-operative Bank in the form specified by NFL against Security Deposit / Performance Guarantee (as applicable) for the faithful and proper fulfilment of the contract. The Bank Guarantee should be valid for Contract period plus defect liability period plus 3 months claims period. The Bank guarantee should be submitted by Bankers directly to NFL in a sealed cover and not through contractor.

The Contractor shall also arrange a copy of swift message, for confirmation of BG (including all amendments) through SFMS mode, from the BG issuing bank generated on communication regarding issue of BG to our designated bank ICICI Bank Ltd, K1, Senior Mall, Sector-18, Noida, UP, 201301, IFSC Code ICIC0000031, as per following details:-

- (i) IFN 76 COV for issuance of bank guarantee
- (ii) IFN 767 COV for amendment of bank guarantee
- (iii) Issuing bank shall mention IFSC code as ICIC0000031 in field 7035 of IFN 76 COV/IFN 767 COV.
- (iv) Issuing bank shall mention NFL beneficiary code as NFLNATIONAL04022015 in field 7037 of IFN76COV/IFN767COV.

25. PERIOD OF LIABILITY: Defect liability period of works shall be 12 months from the actual date of completion of work. The contractor shall at his own cost and initiative, correct repair and/or rectify any / and all defect(s) and/or imperfections in the design of the work (in so far as the contractor shall

be concerned with the design of the work or any part thereof) and/or in the work performed and/or materials, components or other items incorporated therein as shall be discovered during the said defect liability period and in the event of the contractor failing to do so, NFL reserves the right to get the same repaired at the risk & cost of the contractor PLUS 25 % Departmental Charges plus applicable GST thereon , and the expenditure so incurred by NFL shall be adjusted towards the said Security Deposit and / or any other due lying with NFL.

26. PROCEDURE FOR MEASUREMENT/BILLING OF WORKS IN PROGRESS:

a) Measurement and Billing:

All measurement shall be in metric system. All the works in progress will be jointly measured by the representative of the Engineer-in-charge and the Contractor's authorized agent. Such measurement will be got recorded in measurement book/sheet by the Engineer-in-charge or the authorized representative and signed in token of acceptance by the Contractor or his authorized representative. The Contractor will submit a bill in approved Performa in Triplicate to the Engineer-in-charge of the work giving abstract and detailed measurements for the various items executed during a month before expiry of the 1st week of the succeeding month.

b) Running Account Payment:

All running account payments shall be regarded as payments by way of advance against the final payment only and not as payments for work actually done.

c) Completion Certificate/Final Bill:

The Engineer-in-charge shall normally issue to the contractor the completion certificate within one month after receiving an application thereof from the contractor after verifying from the completion documents and satisfying himself that the work has been completed in all respect in accordance with the instructions, specifications of contract documents. The contractor after obtaining the completion certificate is eligible to present the final bill for the work executed by him. The final bill shall be prepared on the basis of the final measurements entered in the measurement books/sheets. The final bill shall be prepared in the prescribed Performa with reference to total work covered by the contract such bill to be drawn up after applying the applicable rates specified in the schedule of rates to the relative measured quantities. The final bill shall also include all additional claims of the contractor and considered conclusive. The final bill, complete in all respects, shall be submitted by the Contractor within one month of the completion of work. No further claim shall be allowed by NFL after Final bill. Contractor shall also furnish "NO CLAIM CERTIFICATE" in the prescribed Performa along with Final Bill.

d) Final Certificate:

Within fifteen days of the contractor's application made after the expiry of the period of defect liability provided for in clause 24.0 here of and satisfaction of all liabilities of the contractor in respect there of the Engineer- in-charge that the contractor has performed his obligations in respect of the defect liability period and until issue of such final certificate, the contractor shall be deemed not to have performed such liabilities notwithstanding issue of the completion certificate or payment of the final bill by NFL.

27.TERMS OF PAYMENT:

a) Payment of monthly running account bill complete in all respect shall be made after making necessary recoveries as per contract within 30 days of receipt of bill by NFL, complete in all respects.

Payment of final bill shall be released within 60 days or otherwise stipulated in the NIT/WO after receipt of bill completed in all respect. Payment of Security deposit deducted shall be released after completion of defect liability period on demand within 30 days. Payment to MSME Parties shall be made with in a period applicable as per MSMED Act or payment terms as per NIT/WO, whichever is earlier.

b) The contractor has the option to receive payment through Electronic Funds Transfer (EFT)/RTGS Process. For this option, they may submit their bank particulars i.e. Customers Name, Name of the Bank, Bank Account No. (All digits in case of CBS branches),Place of branch, Branch Code (IFSC CODE-II digits) to enable NFL to release payment accordingly. All bank charges will be to their account.

c) Contractor shall submit bill in triplicate to the Department along with measurement sheet duly verified by area in-charge. The area in-charge will forward the bill after verification to F&A Department for payment through HOD.

d) NFL shall deduct TDS-Income Tax as per Income Tax Act, TDS/TCS–GST wherever applicable as per GST law, Commercial Tax, Cess including BOCW Cess at source from all payments due and to be made to the Contractor under this contract in accordance with provisions of relevant Act and Rules framed there under including any amendment and modifications thereof as applicable from time to time.

e) The contractor shall furnish along with each running bill a certificate that he has complied with statutory provisions relating to Minimum Wages, PF & ESI and Contract Labour (R&A) Act, 1970 etc. and shall also submit copies of Wage Sheet, PF & ESI Challan(along with ECR and payment confirmation receipt).

f) Bill should be signed by a person holding power of attorney or authorized representative of contractor.

g) In addition to above terms, payment of final bill will be made subject to, inter alia, following terms:

1. Payment of final bill will be made to the contractor after submission of certificate from CISF Gate that all the gate passes issued to the labour of the contractor have been returned alternatively no objection certificate may be provided from CISF.
2. The Payment of final bill will not be made until the contractor has handed over the peaceful vacant possession of land, if any, handed over to him free from all encumbrances including offices, stores, workshop, temporary structure, lighting, fixture poles etc.
3. Return of empty packing material, scrap and unconsumed material issued by NFL.
4. The contractor shall be required to give a certificate along with final bill that he has made all payments towards wages as defined under the Payment of Wages Act, 1936 and Contract Labour (R&A) Act, 1970 and has also complied with other provisions of Labour Laws in respect of manpower engaged/employed for the execution of work.
5. The contractor is further required to give an undertaking stating that in case any dispute arises on account of deployment of manpower/labour, contractor would be responsible to discharge the statutory obligations, if any, and NFL will stands indemnified against any such claim/demand made in future.

6. Following documents (as applicable) and documents to comply with statutory requirement shall be submitted along with the final bill after the successful execution of the job:
 - a. Undertaking for compliance of the labour laws in the prescribed format
 - b. No claim certificate in the format approved by NFL
 - c. No dues certificate form respective sections.
 - d. Self-attested copy of the ESI challan along with contribution history, separately for this contract.
 - e. Self-attested copy of the PF challan, Payment confirmation receipt, ECR with respect to PF deposit, separately for this contract.
 - f. Indemnity letter regarding statutory dues (PF, ESI, Minimum Wages, Labour Welfare Fund if applicable etc.) in the prescribed format
 - g. Self-attested copy of the wage sheet, attendance record, employee register and Loan/recovery in revised format of A,B,C&D.
 - h. Return of Gate passes issued by CISF / NOC from CISF

28.PRESERVATION OF FREE ISSUE MATERIAL: All materials issued to the contractor by the owner shall be preserved against deterioration and storage while under contractor's custody, Any damage/losses suffered on account of non- compliance with the requirement stipulated herein shall be considered as losses suffered due to willful negligence on the part of the contractor and he shall be liable to compensate NFL for the losses suffered at panel rates to be determined by the Engineer-in-charge with reference to the rates charged for the purpose of recovery shall be final and binding on the contractor.

29.SCRAP ALLOWANCE: Contractor will plan the work in such a way that the wastage to be minimum Following scrap allowance will be allowed. Beyond the allowance, the wastage will be chargeable to the contractor on NFL rate +25% + All Taxes will be charged extra.

Sl. No.	PARTICULARS	SALVAGEABLE
1	STRUCTURE	2.5%
2	PIPE	3.0%
3	CEMENT	3.0%

30.ISSUE OF MATERIAL FROM NFL: Any issue of materials from NFL stores not covered in NFL obligation will be issued and charged on NFL issue rate +25% + All Taxes will be charged extra. The issue of such material will be at sole discretion of NFL.

31.ISSUE OF GAS CYLINDER:

Contractor has to make his own arrangement for Oxygen and Acetylene Gas. However, the Oxygen and Acetylene gas can be issued on chargeable basis in exigencies subject to the availability constituting following components.

- a) Invoice price of gas.
- b) Rent for each Cylinder per day.
- c) Department charges.
- d) Cost of collection and return of empty Cylinder.

32. **MATERIAL TRANSPORTATION:** The contractor shall make his own arrangement for Transportation of the material from stores to site of work and to the place of erection etc. at his own cost for making temporary stores/work sites, NFL may indicate an area at its own discretion for putting up of a temporary hut/shed.
33. **Liquidated Damages (LD):** The time and date of completion of work as stipulated in the contract shall be deemed to be essence of the contract. In the event of work is not completed according to the time schedule, the contractor shall have to pay Liquidated Damages to the NFL at the rates of 1 % of the total value of work excluding taxes for delay of every week or part thereof, subject to a ceiling of 10% of the total value excluding taxes of the work plus if applicable GST thereon. These Liquidated Damages shall be recovered from the RA/Final Bill of the contractor of this work, or from any other dues of the contractor against any other contract, or from any other dues of contractor lying with NFL.
34. **ENGINEER-IN-CHARGE:** The Engineer-in-charge shall have general supervision and direction of the work. He has authority to stop the work whenever such a stoppage may be necessary to ensure the proper execution of the contract. He shall also have authority to reject all work which directs the application of forces to any portion of the work as in his judgment is required and order force increased or diminished and to decide disputes, which arise in the execution of the work. The Engineer-in-charge reserves the right to suspend the work or the part thereof at any time and no claim whatsoever on this account will be entertained. In case of any dispute the contractor may appeal to the Engineer-in-charge whose decision shall be final and binding.
35. **JURISDICTION:** Notwithstanding any other court or courts having jurisdiction to decide the question(s) forming the subject matter of the reference if the same had been the subject matter of a suit, any and all actions and proceedings arising out of or relating to the contract (including any arbitration in terms thereof) shall lie only in the court of Competent authority civil jurisdiction in this behalf at (place of unit/zo /New Delhi in case of CO/CMO where this contract has been signed on behalf of the owner) and only the said courts shall have jurisdiction to entertain and try such action(s) and / or proceeding (s) to the exclusion of all other courts.

36. **CONCILIATION & ARBITRATION:**

(i) **FOR INDIAN PARTIES**

Any dispute or difference whatsoever arising between the parties out of or relating to the construction, meaning, scope, operation or effect of this contract or the validity or breach thereof shall be resolved amicably through negotiations by the parties. A “Notice of Dispute” shall be given by the party seeking resolution of a dispute to the other party. If the dispute is not resolved within Thirty (30) days from the notice, the dispute shall be referred to arbitration as per the procedure mentioned herein below:

A written notice shall be given by the contractor invoking arbitration to National Fertilizers Limited through Designated Authority (CMD / Functional Directors/ Unit Head).

Where the claim including determination of interest, if any, being claimed up to the date of commencement of arbitration does not exceed Rs. Five crore, the reference shall be made to a sole arbitrator. The parties shall mutually agree on the name of sole arbitrator. In case of disagreement upon the name of the sole arbitrator, the appointment of Sole Arbitrator shall be done in accordance with the provisions of Arbitration & Conciliation Act, 1996. _____

Where the claim including determination of interest, if any, being claimed up to the date of commencement of arbitration exceed Rs. Five crores, the reference shall be made to arbitral tribunal consisting of three arbitrators. Each party shall nominate one arbitrator each within 30 days from the date of receipt of notice of invocation of arbitration and two nominated arbitrators shall appoint the presiding arbitrator within 30 days thereafter. If a party to the dispute refuses or neglects to nominate an arbitrator on its behalf within the period specified, or the two arbitrators fails to nominate Presiding arbitrator, appointment of Arbitrator(s) shall be done in accordance with the provisions of Arbitration & Conciliation Act, 1996.

The Arbitration proceedings shall be governed by the Arbitration & Conciliation Act, 1996 and any further statutory modification or re-enactment thereof and the rules made thereunder.

It is agreed by and between the parties that in case a reference is made to the Arbitrator for the purpose of resolving the disputes/ differences arising out of the contract by and between the parties hereto, the Arbitrator shall not award interest on the awarded amount more than the rate of SBI PLR / Base Rate applicable to NFL on date of award of contract.

The Seat and venue of Arbitration shall be at Delhi/Place of respective unit /place of Zonal office.

The cost of the proceedings shall be equally borne by the parties, unless otherwise directed by the arbitral tribunal. The decision of the arbitral tribunal shall be final and binding on all parties.

(ii) Arbitration for Foreign Vendors /Parties:

Any dispute arising out of or in connection with this contract, including any question regarding its existence, validity or termination, shall be referred to and finally resolved by Arbitration administered by the Singapore International Arbitration Centre (“SIAC”) in accordance with the Arbitration rules of Singapore International Arbitration Centre (“SIAC Rules”) for the time being in force, which rules are deemed to be incorporated by reference in this clause.

The Seat and venue of Arbitration shall be at New Delhi, India. The language of the Arbitration shall be English.

This contract/LOI/NIT shall be governed by and construed in accordance with the Laws of India.

(iii) Arbitration for CPSEs and Government Department:

In the event of any dispute or difference relating to the interpretation and application of the provisions of commercial contract(s) between Central Public Sector Enterprises (CPSEs) / Port Trusts inter se and also between CPSEs and Government Departments / Organizations (other than those related to taxation), such disputes or differences shall be taken by either party for resolution through AMRCD as mentioned in DPE OM No. 4(1)/2013- DPE(GM)/FTS-1835 dated 22- 05- 2018.

37.CONTRACTOR TO REMOVE UNSUITABLE EMPLOYEES:

The contractor shall on instruction of the Engineer-in-charge immediately remove from the work any person employed thereon who may misbehave or cause any nuisance or otherwise, in the opinion of the Engineer-in-charge is not a fit person to be retained on the work and such person shall not be

again employed or allowed on the works without the prior written permission of the Engineer-in-charge.

38.SAFETY REGULATION:

The contractor shall observe and abide by all fire and Safety regulations of the NFL. Before starting maintenance work, the Contractor shall consult NFL's Safety Officer or the Engineer-in-charge. If the Safety Engineer is not available, he will do familiarize him with such regulations, copies of which will be furnished to him by NFL, when requested. He shall be responsible for and must make good to the satisfaction of the NFL any loss or damage due to fire to any portion of the work to be done under this agreement or to any of the NFL's existing property. All the accidents to contractor's staff will be reported to the Safety Officer promptly.

This will however not relieve the contractor of any statutory obligation. The contractor shall not undertake any hot job without safety work permit. He has to maintain First Aid Box in his office. Also, necessary safety equipment like Helmets, Hand Gloves, Face Shield, Safety Belt etc. are to be provided to his workmen by the contractor. However special Safety equipment required as per the job requirement will be provided by NFL free of cost.

For any default / accident / loss due to negligence of Contractor or its workers, the liability of Contractor shall be "Absolute liability".

39.CONTRACTOR TO EXECUTE AGREEMENT:

The contractor's responsibility under this contract will commence from date of issue of the Letter of Intent. The Tender Documents, other documents exchanged between the Tenderer and NFL, the letter of acceptance and work order shall constitute to the contract. The successful Tenderer shall be required to execute an agreement on a non-judicial stamp paper of prescribed values with NFL within 15 days (Fifteen days) of receipt by him of the Letter of Intent. The agreement to be executed will be in Agreement Form specified by NFL. The cost of the Stamp Papers will be borne by the contractor. Until a formal agreement is prepared and executed, acceptance of this tender shall constitute a binding contract between the parties.

40.BIDDER TO ACQUAINT HIMSELF FULLY

The Bidder may visit the site and shall acquaint himself fully and thoroughly with the conditions and limitations including scope, requirements and official/statutory regulations, under which, conforming to which and subject to which, services/work are to be performed by him. Failure to comply with the aforesaid requirements will not relieve the BIDDER of his obligations in the event of his tender being accepted nor will any claim whatsoever be entertained on the plea of ignorance or overlooking.

The Bidder shall give an undertaking that the terms and conditions of NIT and other aforesaid conditions are acceptable to him without reservations and no deviations to NIT have been taken while making the offer.

Unless otherwise specifically stated in his bid, it will be assumed that all terms and conditions of NIT are accepted by the bidder without any reservations whatsoever.

41.PAYMENT FOR PREPARATION OF BID DOCUMENT: The Bidder shall not be entitled to claim any cost, charges, expenses, losses incidental to the preparation and submission of this tender in any case.

41.1 TERMINATION OF CONTRACT

Notwithstanding anything elsewhere herein provided and in addition to any other right or remedy of NFL under the Contract or otherwise including right of NFL for compensation for delay the Engineer-in-charge/officer-in-charge may, without prejudice to his right against Contractor in respect of any delay, bad workmanship or otherwise or to any claims for damage in respect of any breaches of the Contract and without prejudice to any rights or remedies under any of the provisions of this Contract or otherwise and whether the date for completion has or has not elapsed by intimation in writing, absolutely, determine the Contract:

Default or failure by Contractor of any of his obligations under the Contract including but not limited to the following, the Contract is liable to be terminated after written notice if the Contractor:

- i) Becomes bankrupt or insolvent or goes into liquidation or is ordered to be wound up or has a receiver appointed on its assets or execution or distress is levied upon all or substantially all of its assets.
- ii) Abandons the work
- iii) Persistently disregards the instructions of the Company in contravention of any provision of the CONTRACT.
- iv) Persistently fails to adhere to the agreed program of work.
- v) Sublets the work in whole or in part thereof without Company's consent in writing.
- vi) Performance is not satisfactory or work is abnormally delayed.
- vii) Defaults in the performance of any material undertaking under this CONTRACT and fails to correct such default to the reasonable satisfaction of the Company within fifteen days after written notice of such default is provided to the Contractor.
- viii) Conceals any material information or submit any false document or information furnished by the contractor regarding past experience and or contents of any document etc. are found false.

41.2 CONSEQUENCES OF TERMINATION

If the contract is terminated by NFL for the reasons detailed under clause no. 41.1 of General Terms and Conditions due to default of the contractor:

- i) NFL reserves the right to get the work completed at the risk and cost of the Contractor and to recover from the Contractor any amount by which the cost of completing the work by any other agency exceeds the value of the contract plus 25% towards administrative cost, without prejudice to any other remedies/rights/claims etc. that may be available with NFL.
- ii) Security Deposit/Performance Bank Guarantee Bond submitted by the Contractor shall stand forfeited.
- iii) The Contractor shall have no right to claim any compensation for any loss sustained by him by reason of his having entered into any commitment or made any advance on account of or with a view to the execution of the works, or on account of expected profits.
- iv) All the dues payable to the Contractor for the work executed by him before and up to termination shall only be released after making adjustments for the expenses, charges, damages and expected losses etc. incurred by NFL as a consequence of the termination of the contract.

- v) Apart from above NFL reserves the right to delist/ blacklist the contractor from the approved list of pre-qualified parties or debar from participating in tendering process of NFL in all units / offices as per NFL's rules & regulations.

41.3 FORECLOSURE:

If at any point of time, after the acceptance of the tender, the Company decides to abandon or reduce the scope of the contract work or to terminate the contract due to any reason including force majeure, regulations or ordinance of any government or for any reasons whatsoever, the Officer in Charge shall give notice in writing, to that effect to the Contractor and the Contractor shall have no claims to any payment, on account of compensation or on account of profit advantage, that he would have derived by way of execution of work, but could not do so, because of foreclosure.

Such foreclosure will be by 15 (fifteen) days' notice in writing and no claim / compensation shall be payable by the OWNER as a result of such termination, excepting the fees and costs for the meaningful services rendered by the CONTRACTOR and acceptable to OWNER up to the date of termination.

42. RIGHTS OF OWNER

A unilateral stoppage of work by the Contractor shall be considered a breach of the CONTRACT and the OWNER reserves its right to take necessary and suitable action as it may deem fit, to adequately protect his/its interest; at the risk and cost of the contractor. Any aforesaid action shall be without prejudice to any other action, rights and remedies etc. that may also be available.

In the event the Contractor fails to fulfil his obligations under the CONTRACT, the OWNER shall have the right to get the work done by any other agency/own resources at the risk and cost of the Contractor.

43. TIME EXTENSION: If the Contractor requires any extension of time for completing the Work under the CONTRACT, he must apply to the OWNER within seven days from the date of the occurrence of the event on account of which he desires such extensions and the OWNER may, if he thinks such request reasonable, grant such extension of time as he may think necessary.

The extension of completion date shall also be subject to the right of NFL to claim a reduction in prices on account of reduction in statutory duties / taxes etc. which may take place during the extended period of completion. However, increase in prices during extended completion period on account of increase in statutory duties/taxes etc. admissible under this work order/contract may be considered only if extension is due to delay on the part of NFL.

Any extension of time given under the provisions of this clause shall be without prejudice to other conditions of Contract and will not absolve the Contractor from the obligations of other clauses under the Contract. The Contractor shall not be entitled to increase in prices or for any compensation whatsoever on account of the extension of time allowed.

Where a Bank Guarantee has been furnished by the Contractor in pursuance of clause (by way of Security Deposit), the Contractor shall immediately arrange to extend the validity of the Bank Guarantee at his cost to adequately cover the extended period of time for completion of work granted under this clause. In addition, the contractor shall ensure that the Labour license, Insurance policy are renewed from time to time at his cost during the extended period of contract till the completion of the project.

44. CONTINUED PERFORMANCE : The Contractor shall not stop work in case of any dispute pending before arbitrator/court/Tribunal in relation to the contract or otherwise unless further progress of works has been rendered impossible due to non-fulfilment of any reciprocal promise. Unilateral stoppage of

work by the Contractor shall be considered a breach of CONTRACT and the OWNER shall be within its rights to take suitable and necessary action as it may deem fit to adequately protect its own interests.

45. Intellectual Property Right : The Contractor shall fully indemnify NFL and all agents, servants and employees of the Company against any action, claim or proceeding relating to infringement or the use of any patent, trademark or design in respect of any article or part thereof included in the Contract. In the event of any claims being made or action being brought against the Company or any agent, or servant, or employee of the Company in respect of any of the matters aforesaid, the Contractor shall be notified thereof for taking necessary action at his cost.

46. Contractor's Obligations w.r.t. personnel deployed and labor related compliance:

a) The CONTRACTOR shall be governed by and shall comply with the provisions of various applicable labour laws like Contract Labour (Regulation & Abolition) Act 1970, Payment of Wages Act 1936, Employers Liability Act 1938, Employment of Children Act 1938, Industrial Disputes Act, 1947, Factories Act, 1948, Minimum Wages Act 1948, Employees' State Insurance Act 1948, Employees' Compensation Act 1923 (in the absence of coverage of employees under Employee State Insurance Act, 1948), Employee Provident Fund & Misc. Provisions Act 1952, Maternity Benefit Act 1961, Payment of Bonus Act 1965, Payment of Gratuity Act 1972, Equal Remuneration Act 1976, Building & Other Construction Workers (Regulation of Employment and Conditions of Service) Act 1996 (BOCW) along with BOCW Welfare Cess Act 1996, or any modifications thereof or any other law/ Code (s) relating thereto and rules made thereunder from time to time. (THE ABOVE ACTS ARE ONLY ILLUSTRATIVE AND NOT EXHAUSTIVE.)

b) The contractor shall comply with all applicable Central, State statutes/ labour laws/codes/schemes including all other applicable statutory rules and regulations in force relating to the contract and keep NFL indemnified in respect thereof.

The contractor shall, to the extent, he is liable, comply with & give all intimation/ notices required under any Government Authority, instrument, rule or order made under any Act of Parliament, State laws or any regulations or bye-laws of any local authority relating to the contract. The Contractor shall, to the extent that he is liable to pay, indemnify NFL against any liability in respect of any fee/ charges/ fines/ penalty payable under any Act of Parliament, State Laws or any Govt. instrument, rule or order or enactment, any regulations, bye-laws of any local authority in respect of the contract awarded. In case of any violations, omissions, commissions, the consequence/s, if any, including the cost thereto shall be exclusively borne by the CONTRACTOR and NFL shall have no liability whatsoever on this account.

c) In case the CONTRACTOR selected for award of contract does not have a PF code, He shall be required to obtain the same within the stipulated time as per EPF act. The contractor shall timely apply and obtain requisite labour licenses & other requisite registrations/ licenses/ clearances from the concerned Authorities and submit a certified stamped copy of the same. Contractor shall ensure its uninterrupted continuity throughout the period of contract/ applicability.

d) The Contractor shall depute only physically and medically fit 'adult' persons against the contract i.e. persons below the age of 18 years shall not be allowed to be engaged for execution of work. The contractor may employ such persons as He may think fit and the persons so employed shall be employees of contractor for all purposes and shall not be deemed to be in the employment of NFL for any purpose whatsoever.

- e) The Contractor shall pay minimum wages directly to the persons employed by him under the Contract, within the stipulated period i.e. by 7th of the following month, by direct credit in his/her bank account through NEFT/RTGS or by way of cheque. The wage rates should not be less than the stipulated minimum wage rates notified by Appropriate Government as per minimum wages act from time to time with respect to the work performed/ rendered, without any discrimination on grounds of caste/ creed/ religion/ gender. CONTRACTOR shall also enroll/cover all eligible/entitled personnel under EPF, EPS, EDLI, ESI, Labour Welfare Fund, & all the other applicable statutory Acts/ Codes/ schemes and ensure deduction & deposition of the requisite contributions – employee's as well as employer's - for the same with the concerned Authorities/ departments within the due date (i.e. 15th of the following month in case of deposition under EPF & Misc. Provisions Act and by 15th of the following month in case of depositions under ESI Act).
- f) The Contractor is also required to discharge all other statutory obligations including timely submission of reports, returns to concerned Authorities and maintain updated registers and records in prescribed proforma under all the various applicable statutes/ Labour Laws/Labour Code(s) including the rules made thereunder enacted and/or amended by the Appropriate Government from time to time
- g) The Contractor is also required to discharge all other statutory obligations including timely submission of reports, returns to concerned Authorities and maintain updated registers and records in prescribed proforma under all the various applicable statutes/ Labour Laws/Labour Code(s) including the rules made thereunder enacted and/or amended by the Appropriate Government from time to time.
- h) The contractor shall on monthly basis submit a certified stamped copy of wage sheet in prescribed formats along-with bank transaction details besides documentary evidence in support of wage payment, deduction & deposition of EPF, ESI, Labour Welfare Fund. The contractor shall also submit a certified stamped copy w.r.t. any other payment made/ benefit extended by him towards fulfilment of his statutory obligations under applicable statutes and/or his contractual obligations towards NFL. Submission of these and other requisite documents/ records and proper maintenance and production of the same as when requisitioned by Authorities/ NFL has to be ensured for smooth clearance/ settlement of bills/payments.
- i) CONTRACTOR shall follow prescribed safety regulations & procedures and shall adhere with safe work practices.

47. Specifications and Drawings:

- (1) Adherence to Specifications and Drawings: The whole of the works shall be executed in conformity with the specifications and drawings of the contract. If Contractor performs any works in a manner contrary to the specifications or drawings or any of them and without such reference to the Engineer, he shall bear all the costs arising or ensuing therefrom and shall be responsible for any loss to NFL.
- (2) Drawings and Specifications of the Works: The Contractor shall keep one copy of Drawings and Specifications at the site, in good order, and such contract documents as may be necessary, available to the Engineer or the Engineer's Representative.
- (3) Ownership of Drawings and Specifications: All Drawings and Specifications and copies thereof furnished by the NFL to the Contractor are deemed to be the property of NFL. They shall not be used on other works and with the exception of the signed contract set, shall be returned by the Contractor to the NFL on completion of the work or termination of the Contract.

48. Signing of "No Claim" Certificate:

The Contractor shall not be entitled to make any claim whatsoever against NFL under or by virtue of or arising out of this contract, nor shall NFL entertain or consider any such claim, if made by the Contractor, after he shall have signed a "No Claim" Certificate in favour of the NFL in such form as shall be required by NFL after the works are finally measured up. The Contractor shall be debarred from disputing the correctness of the items covered by "No Claim" Certificate or demanding a clearance to arbitration in respect thereof.

49. No CONTRACT or understanding in any way modifying the conditions of CONTRACT shall be binding upon either parties hereto unless made in writing and approved by both parties.

50. INDEMNIFICATION: The contractor shall have to furnish Indemnity Bond for value specified in Special Terms and Conditions towards the material being sent for repair (This Clause shall be applicable for repair of materials).

51. The contract shall be governed by and construed in accordance with the Laws of India.

52. Integrity Pact: In case of contract valuing Rs 1 crore and above, the Bidder(s) / Contractor(s) is required to enter into an "Integrity Pact" with the Principal i.e. NFL. The Integrity Pact has to be signed by the Proprietor / Owner/ Partner/ Director or by their duly Authorized Signatory. In case of failure to return the Integrity Pact along with the offer/ bid, duly signed by the authority as mentioned above, will disqualify the offer/ bid.

53. Technical Terms and Condition, Special Terms and Condition are Succeeding to GTC. In case of any discrepancy or inconsistency between Special terms and condition and general terms and conditions, the following order of preference shall be followed: -

1. Scope of work /Technical terms and Condition
2. Special Terms and Condition
3. General Terms and Condition (GTC/GTCC)

Performa for proprietorship Affidavit on the stamp paper of appropriate and Notary attested

I, _____ S/o Sh. _____ resident of _____
_____do hereby solemnly affirm and declare as under:

- (1) That on _____(date of start of business) I the deponent has started business under the name and style of Proprietorship as a sole proprietor and at present M/s _____ is a sole proprietorship firm.
- (2) That I am the sole proprietor of the firm named as _____situated at _____(full address of firm with pin code).
- (3) That my above declarations are true and correct in case, my above declaration found incorrect, in that event, my bid / tender/contract may be rejected and NFL shall be fully competent to take the necessary action as deemed fit.

DEPONENT

VERIFICATION

Verified that the above contents of my affidavit are true and correct to the best of my knowledge and belief and nothing has been concealed therein.

DEPONENT

Place _____
Date: _____

**PROCUREMENT FROM A BIDDER WHICH SHARES A LAND BORDER WITH
INDIA**

- (1) Order (Public Procurement No. 1) dated 23.07.2020, Order (Public Procurement No. 2) dated 23.07.2020 and Order (Public Procurement No. 3) dated 24.07.2020, Department of Expenditure, Ministry of Finance, Govt. of India refers. The same are available at website <https://doe.gov.in/procurement-policy-divisions>.
- (2) Any bidder from a country which shares a land border with India will be eligible to bid in this tender only if the bidder is registered with the Competent Authority. For details of competent authority refer to Annexure I of Order (Public Procurement No. 1) dated 23.07.2020. Further the above will not apply to bidders from those countries (even if sharing a land border with India) to which the Government of India has extended lines of credit or in which the Government of India is engaged in development projects. Updated lists of countries to which lines of credit have been extended or in which development projects are undertaken are given in the website of the Ministry of External Affairs, Govt. of India.
- (3) "Bidder" (including the term 'tenderer', 'consultant' 'vendor' or 'service provider' in certain contexts) for purpose of this provision means any person or firm or company, including any member of a consortium or joint venture (that is an association of several persons, or firms or companies), every artificial juridical person not falling in any of the descriptions of bidders stated hereinbefore, including any agency, branch or office controlled by such person, participating in a procurement process.
- (4) "Bidder from a country which shares a land border with India" for the purpose of this:
 - a. An entity incorporated, established or registered in such a country; or
 - b. A subsidiary of an entity incorporated, established or registered in such a country; or
 - c. An entity substantially controlled through entities incorporated, established or Registered in such a country; or
 - d. An entity whose beneficial owner is situated in such a country; or
 - e. An Indian (or other) agent of such an entity; or
 - f. A natural person who is a citizen of such a country; or
 - g. A consortium or joint venture where any member of the consortium or joint venture falls under any of the above
- (5) "Beneficial owner" for the purpose of above (4) will be as under:
 - (i). In case of a company or Limited Liability Partnership, the beneficial owner is the natural person(s), who, whether acting alone or together, or through one or more juridical person(s), has a controlling ownership interest or who exercises control through other means.
Explanation—
 - a) "Controlling ownership interest" means ownership of, or entitlement to, more than twenty-five per cent of shares or capital or profits of the company;
 - b) "Control" shall include the right to appoint the majority of the directors or to control the management or policy decisions, including by virtue of their shareholding or management rights or shareholders agreements or voting agreements;
 - (ii). In case of a partnership firm, the beneficial owner is the natural person(s) who, whether acting alone or together, or through one or more juridical person, has ownership of entitlement to more than fifteen percent of capital or profits of the partnership;
 - (iii). In case of an unincorporated association or body of individuals, the beneficial owner is the natural person(s), who, whether acting alone or together, or through one or more juridical person, has ownership of or entitlement to more than fifteen percent of the property or capital or profits of such association or body of individuals;

- (iv). Where no natural person is identified under (i) or (ii) or (iii) above, the beneficial owner is the relevant natural person who holds the position of senior managing official;
- (v). In case of a trust, the identification of beneficial owner(s) shall include identification of the author of the trust, the trustee, the beneficiaries with fifteen percent or more interest in the trust and any other natural person exercising ultimate effective control over the trust through a chain of control or ownership
- (6) "Agent" for the purpose of this Order is a person employed to do any act for another, or to represent another in dealings with third persons.

- (7) **SUBMISSION OF CERTIFICATE IN BIDS:**
Bidder shall submit a certificate in this regard as **Form-I**. If such certificate given by a bidder whose bid is accepted is found to be false, this would be a ground for immediate rejection of the bid/termination and further action as per— Procedure for Action in case of Corrupt/Fraudulent/ Collusive / Coercive Practices|| of tender document

- (8) The registration, wherever applicable, should be valid at the time of submission of bids and at the time of acceptance of bids. In respect of supply otherwise than by tender, registration should be valid at the time of placement of order. If the bidder was validly registered at the time of acceptance / placement of order, registration shall not be a relevant consideration during contract execution.

- (9) **PROVISION FOR WORKS CONTRACTS, INCLUDING TURNKEY CONTRACTS:**
The successful bidder shall not be allowed to sub-contract works to any contractor from a country which shares a land border with India unless such contractor is registered with the Competent Authority. The definition of "contractor from a country which shares a land border with India" shall be as in Para 4 herein above. A Certificate to this regard is to be submitted by bidder is placed at Form-II

Form-I
UNDERTAKING ON LETTERHEAD

To,
M/s NATIONAL FERTILIZERS LIMITED

SUB: TENDER NO: NFL/PT/M/A/13.442, NIT Dated 21.05.2024

Dear Sir,

We have read the clause regarding Provisions for Procurement from a Bidder which shares a land border with India, we certify that, bidder M/s_____ (Name of Bidder) is:

- (i) Not from such a country
- (ii) If from such a country, has been registered with the Competent Authority.

**(Evidence of valid registration by the Competent Authority shall be attached)
(Bidder is to tick appropriate option (✓ or ×) above).**

We hereby certify that bidder M/s_____ (Name of Bidder) fulfills all requirements in this regard and is eligible to be considered against the tender.

Place:

[Signature of Authorized Signatory of Bidder]

Date:

Name:

Designation:

Seal:

Form-II

CERTIFICATE FOR TENDERS FOR WORKS INVOLVING POSSIBILITY OF SUBCONTRACTING

To,
M/s NATIONAL FERTILIZERS LIMITED

SUB: TENDER NO: **NFL/PT/M/A/13.442, NIT Dated 21.05.2024**

Dear Sir

We have read the clause regarding Provisions for Procurement from a Bidder of a country which shares a land border with India and on sub-contracting to contractors from such countries; we certify that, bidder M/s_____ (Name of Bidder) is:

- (i) Not from such a country []
- (ii) If from such a country, has been registered [] with the Competent Authority.

**(Evidence of valid registration by the Competent Authority shall be attached)
(Bidder is to tick appropriate option (✓ or ✕) above).**

We further certify that bidder M/s_____ - (Name of Bidder) will not sub-contract any work to a contractor from such countries unless such contractor is registered with the Competent Authority.

We hereby certify that bidder M/s_____ (Name of Bidder) Fulfills all requirements in this regard and is eligible to be considered.

Place:

[Signature of Authorized Signatory of Bidder]

Date:

Name:
Designation:
Seal:

SECURITY DEPOSIT-CUM-PERFORMANCE BANK GUARANTEE FORMAT
(To be prepared on Stamp paper issued in the name of Bank)

This BANK GUARANTEE No.____made this day of____between_____a bank incorporated and having its registered office at_____(hereinafter called BANK) which expression shall unless repugnant to the context or contrary to the meaning thereof include its successors and assigns on the one part and NATIONAL FERTILIZERS LIMITED, a Company registered in India under Companies Act, 1956 and having its registered office at Core -III, Scope Complex, 7, Institutional Area, Lodhi Road, New Delhi -110 003, India (Hereinafter referred to as "Owner") which expression shall unless repugnant to the context or contrary to the meaning thereof include its successors and assigns on the other part.

WHEREAS in pursuance to the agreement dated_(hereinafter called CONTRACT) entered into between National Fertilizers Limited and_____a Company incorporated in_____(hereinafter called CONTRACTOR) which expression shall unless repugnant to the context or contrary to the meaning thereof include its successors and assigns, for supply of_____as envisaged in the Contract, Contractor has to submit a Security Deposit-cum-Performance Bank Guarantee for Rs.____. CONTRACTOR accordingly agrees to furnish the Security cum performance Bank Guarantee as hereinafter contained towards fulfilment of all of its obligations under the contract.

NOW THIS DEED WITNESSES AS FOLLOWS:

The decision of the Owner as to whether the terms and conditions of this Security Deposit- cum-Performance Bank Guarantee have been observed or not shall be final and binding on the BANK. In any case, however the Bank's responsibility under this Security Deposit-cum-Performance Bank Guarantee is limited to Rs._____.

1. In pursuance of the Contract, the Bank hereby guarantees as a direct responsibility to OWNER that the BANK is holding the amount of Rs.____at Owner's disposal and hereby promises and shall be bound to pay to OWNER, forthwith at Owner's written notice stating that the contractor has failed to fulfil its obligations under the contract for reasons for which contractor is liable and without any protest or demur and without recourse to contractor and without asking for any reasons as to whether the amount if lawfully asked for by Owner or not, the entire amount or the portion thereof as mentioned by Owner in the notice.
2. This Security Deposit-cum-Performance Bank Guarantee shall be valid for an initial period of____ months from the date of this Bank Guarantee No._dated_____given by the Bank to Owner become effective. Upon issuance of Commissioning / certificate according to terms of contract on expiry of_____months after the issuance of the above mentioned certificate of commissioning / erection / completion certificate, the Security Deposit-cum- Performance Bank Guarantee shall become null and void.
3. This Security Deposit-cum-Performance Bank Guarantee shall be in addition to and shall not affect or be affected by any other security now or hereafter held by Owner on account of money hereby intended to secure and Owner at its discretion and without any further consent from the Bank, and without affecting its rights against the Bank, may compound with, give time or other indulgence to or make any other arrangement with Contractor and nothing done or omitted to be done by Owner in pursuance of any authority or permission contained in this guarantee, shall effect discharge of the liability of the Bank.

4. UNLESS PREVIOUSLY CANCELLED BY THE OWNER, this Security Deposit-cum- Performance Bank Guarantee will remain in force initially upto _____ months from the effective date of Bank Guarantee No. _____ dated _____ given by the Bank to the Owner and subject to provisions of paragraph 2 above will stand automatically cancelled on the expiry of the said period. Unless demand or claim under this Bank Guarantee is made on Bank in writing within three months from the date of expiry of this Bank Guarantee, all the rights of Owner against the Bank shall be forfeited and Bank shall be relieved and discharged from all the liabilities hereunder.
5. Any notice by way of request, demand or otherwise hereunder may be sent by post to the Bank, addressed as aforesaid, and if sent by post, it shall be deemed to have been given at the time when it would be delivered in due course of post, and in proving such notice, when given by post, it shall be sufficient to prove that the envelope containing the notice was posted and a certificate, signed by an officer of the owners, to the effect that the envelope was so posted, shall be conclusive.
6. The Security Deposit-cum-Performance Bank Guarantee is to be returned to the Bank after its expiry in terms of Paragraph 4 above.
7. This guarantee will not be discharged due to the change in constitution of the Bank or the Contractor(s). Also the guarantee will not be discharged due to change in the constitution or Management of NFL (owner).
8. The Bank declares that it has the power to issue this guarantee and the undersigned have full power to do so.

Dated:

(Indicate the name of the Bank with stamp)

E-Tendering Guidelines

- 1). Enrolment process in the Tender site
 1. Bidders are required to enrol on the e-Procurement module of the Central Public Procurement Portal (URL: <https://etenders.gov.in/eprocure/app>) by clicking on the link "Online Bidder Enrolment". Enrolment on the Portal is free of charge.
 2. As part of the enrolment process, the bidders will be required to choose a unique username and assign a password for their accounts.
 3. Bidders are advised to register their valid email address and mobile numbers as part of the registration process. These would be used for any communication from the Portal.
 4. Upon enrolment, the bidders will be required to register their valid Digital Signature Certificate (Class III Certificates with signing key usage) issued by any Certifying Authority recognized by CCA India, with their profile.
 5. Only one valid DSC should be registered by a bidder. Please note that the bidders are responsible to ensure that they do not lend their DSCs to others which may lead to misuse.
 6. Bidder then logs in to the site through the secured log-in by entering their user ID /password and the password of the DSC / e-Token.
- 2). Tender search
 1. There are various search options built in the Portal, to facilitate bidders to search active tenders by several parameters. These parameters could include Tender ID, organization name, location, date, value, etc. There is also an option of advanced search for tenders, wherein the bidders may combine a number of search parameters such as organization name, form of contract, location, date, other keywords etc. to search for a tender published on the Portal.
 2. Once the bidders have selected the tenders they are interested in, they may download the required documents / tender schedules. These tenders can be moved to the respective 'My Favourites' folder. This would enable the Portal to intimate the bidders through SMS / e-mail in case there is any corrigendum issued to the tender document.
 3. The bidder should make a note of the unique Tender ID assigned to each tender, in case they want to obtain any clarification / help from the Helpdesk.
- 3). Preparation of bids
 1. Make folders with the name of the tender number so as to identify the folders easily during the bid document uploading.
 2. File and Folder name should not contain any special characters (&, #, etc) or space in between.
 3. Download the tender document, NIT, BOQ of the required tender in that folder.
 4. Scan the EMD fee instruments/ Tender fee instruments for offline payments if any.
 5. In the case of offline payment, the details of the DD/any other accepted instrument, physically sent, should tally with the details available in the scanned copy and the data entered during bid submission time. Otherwise the bid submitted will not be acceptable.
 6. Scan and keep ready Pre-qualification documents like life certificates, PAN etc if any
 7. Prepare the technical bid document and then convert into PDF
 8. Prepare the BOQ i.e. fill up required figures in the downloaded XLS document. The BOQ file with the same name has to be uploaded while uploading the financial bids. If there is any change in Name it may not get uploaded or give an error.
 9. Keep all the documents in the same folder for the easy bid document upload
 10. The bid summary has to be printed and kept as an acknowledgement as a token of the

submission of the bid. It will act as a proof of bid submission for a tender floated and will also act as an entry point to participate in the bid opening date. For any clarifications with the TIA, the bid no can be used as a reference.

4). Submission of bids

1. Bidder should log into the site well in advance for bid submission so that he/she upload the bid in time i.e. on or before the bid submission time. Bidder will be responsible for any delay due to other issues.
2. The bidder has to digitally sign and upload the required bid documents one by one as indicated in the tender document.
3. **Bidder should prepare the EMD as per the instructions specified in the tender document. The original should be Posted/couriered/given in person to the Tender Processing Section, latest by the last date of bid submission. The details of the DD/any other accepted instrument, physically sent, should tally with the details available in the scanned copy and the data entered during bid submission time. Otherwise the uploaded bid will be rejected.**
4. If a standard BOQ format has been provided with the tender document to be filled by all the bidders. Bidders are requested to note that they should necessarily submit their financial bids in the format provided and no other format is acceptable. Bidders are required to download the BOQ file, open it and complete the while colored (unprotected) cells with their respective financial quotes and other details (such as name of the bidder). No other cells should be changed. Once the details have been completed, the bidder should save it and submit it online, without changing the filename. If the BOQ file is found to be modified by the bidder, the bid will be rejected.
5. The serve time (which is displayed on the bidders' dashboard) will be considered as the standard time for referencing the deadlines for submission of the bids by the bidders, opening of bids etc. The bidders should follow this time during bid submission.
6. All the documents being submitted by the bidders would be encrypted using PKI encryption techniques to ensure the secrecy of the data. The data entered cannot be viewed by unauthorized persons until the time of bid opening. The confidentiality of the bids is maintained using the secured Socket Layer 128 bit encryption technology. Data storage encryption of sensitive fields is done.
7. Any document that is uploaded to the server is subjected to symmetric encryption using a system generated symmetric key. Further this key is subjected to asymmetric encryption using buyers / bid-openers public keys. Overall, the uploaded tender documents become readable only after the tender opening by the authorized bid openers. Upon the successful and timely submission of bids, the portal will give a successful bid submission message & a bid summary will be displayed with the bid no. and the date & time of submission of the bid with all other relevant details.
8. The bid summary has to be printed and kept as an acknowledgement of the submission of the bid. This acknowledgement may be used as an entry pass for any bid opening meetings.

5). Password maintenance

1. The length of the password should be of 8 to 32 characters.
2. The password should be of any English lowercase and uppercase (a-z and AZ) characters.
3. The password must contain at least one number between 0-9.
4. The password must contain at least one special character from these [! @ # \$ ^ * _ ~]
5. Sample password is just like Admin123\$, India2000#, etc.

6). About DSC

1. Digital Signature Certificates (DSC) is the digital equivalent (that is electronic format) of physical paper certificates.
2. Like physical documents are signed manually, electronic documents, for example e-forms are required to be signed digitally using a Digital Signature Certificate. Transactions that are done using Internet if signed using a Digital Signature certificate becomes legally valid.
3. Bidders have to procure Class 3 signing certificates only. Only Class 3 is valid for e-tendering purpose.
4. The Certifying Authorities are authorized to issue a Digital Signature Certificate with a validity of one or two years. The maximum period for which the DSC is issued is only two years. On the expiry of the term, the Digital Signature Certificate can be revalidated by paying the fees again.
5. Digital Signatures are legally admissible in a Court of Law, as provided under the provisions of IT.
6. Digital Signature Certificate (DSC) is not required by Companies but by individuals. For example the Director or the Authorized signatory signing on behalf of the Company requires a DSC.
7. Each user logs in to the tender site thro' the secured log in by giving the user id/ password allotted during registration & then by giving the password of the DSC. The DSC password will get locked if successively wrong password is given many times.

7). DSC providers for Private firms

A licensed Certifying Authority (CA) issues the digital signature. Certifying Authority (CA) means the authority that has been granted a license to issue a digital signature certificate under Section 24 of the Indian IT-Act 2000.

- i. The vendors like TCS (www.tcs-ca.tcs.co.in), Sify, MTNL, nCode (dsc@ncodesolutions.com), e-Mudhra (www.e-mudhra.com) are issuing DSC's for bidders.
- ii. The time taken by Certifying Authorities to issue a DSC may vary from three to seven days.

8). Advantage of "My Space" on Portal

1. The bidder can upload Non Sensitive frequently asked documents prior at any point of time once he logs in to the application. These are not encrypted.
2. The can be anything like PAN Certificate, VAT Certificate, Equipment Details, Manpower Details, Copies of Balance Sheet of last few years, Details of quantity of work executed etc.
3. In some cases the TIA might have uploaded a format while in many cases it may just be a scanned copy of the original which needs to be uploaded.
4. This will avoid repeated upload of common documents and also save space and time.

9). System requirements

1. Windows XP with latest service pack / Windows 7 / Windows 10
2. Loaded IE 7.0 or above
3. Loaded JRE 1.6 or above
4. Antivirus Software with latest definition.
5. Internet connectivity
6. Scanner to scan the documents if required
7. Printer and PDF Creator.

10). Assistance to Bidders

- (i) Any queries relating to the tender document and the terms and conditions contained therein should be addressed to the Tender Inviting Authority for a tender or the relevant contact person indicated in the tender.
- (ii) Any queries relating to the process of online bid submission or queries relating to tender Portal in general may be directed to the 24x7 CPP Portal Helpdesk. The contact number for the helpdesk is 1800 233 7315.
- (iii) All the vendors participating in the online e-tendering have to abide by the process involved in the entire workflow of the e-tendering.
- (iv) NFL is not responsible for any mistake made by the vendor at the time of bidding process. In case any vendor submits an invalid bid due to any reason including typing mistake / human error, such invalid bid will be disqualified and such vendor shall not be allowed to further participate in that tender. The remaining process shall be completed considering the other valid bids.
- (v) For submitting price bid through e-Auction, the successful Pre-qualified Vendors will have to use a Class III Digital Signature Certificate issued by any India CA approved by CCA of India as per IT Act 2000.
- (vi) It is mandatory for the vendors to use the digital certificate in all their bidding Process.
- (vii) It is the entire responsibility of the vendors to protect their own login id and Password and keep their digital certificate safe so that is not misused by any other person.

CONTRACT AGREEMENT

THIS CONTRACT made -----on this----- day of-----2024 at----- (Place) BETWEEN NATIONAL FERTILIZERS LIMITED (NFL), a Public Sector Undertaking (PSU) under the Administrative Control of Department of Fertilizers, Ministry of Chemicals & Fertilizers having its Registered Office at SCOPE Complex, Core-III, 7, Institutional Area, Lodhi Road, New Delhi-110003 and its Unit/ Office at _____ (hereinafter referred to as the "Owner", which expression shall be deemed to include its successors and assigns) through its authorized representative of the one Part.

AND

M/s _____ (carrying on business in sole-proprietor/partnership/ company etc.) having its office/ registered office at _____ (hereinafter referred to as "Contractor", which expression shall be deemed to include his/its representatives/successors and permitted assigns) through its authorized representative of the other Part.

WHEREAS the Owner is desirous of executing certain works as mentioned and described in the Work Order/ Letter of Intent No. _____ dated _____ for total Contract value of Rs. _____ (Rs. _____ Only) and whereas the Contractor has agreed to execute the work as specified in the Tender Documents and Work Order/ Letter of Intent referred to above and also in the contract documents.

NOW THEREFORE THIS CONTRACT WITNESSTH AS FOLLOWS:

ARTICLE – I

1.0 CONTRACT DOCUMENTS

1.1 The following documents shall constitute the contract documents namely: -

- a. This Contract
- b. Tender Document/NIT
- c. Work Order No. _____ dated _____
- d. Letter of Intent / Notification of Award No. _____ dated _____
- e. Contractor Quotation/bid dated _____.
- f. Owner's Tender Document/ NIT No. _____ dated _____
- g. Amendment/ Addendum/ Corrigendum dated _____ (If any) to Tender Document/NIT.
- h. Owner's Letter/email dated _____ (If any).
- i. Contractor's Letter/email dated _____ (If any).

1.2 A copy each of the above documents (a) to (h) are annexed hereto and the said copies have been collectively marked Annexure-I.

ARTICLE –2

2.0 SCOPE OF WORK

2.1 In consideration of the payment to be made to the Contractor as hereinafter provided, he shall with due care, promptness, accuracy and workmanship execute the work in accordance with approved plans, Notice Inviting Tender (NIT), Special Conditions of the Contract, General Terms & Conditions of the Contract, Technical Specifications and the Work Order/ Letter of Intent.

ARTICLE-3

3.0 TERM

3.1 The Contract work shall be duly executed and completed in all aspect and handed over to National Fertilizers Ltd. within a period of ____months/year w.e.f. _____to____. The time mentioned herein shall be essence of the contract.

ARTICLE-4

4.0 TERMINATION OF CONTRACT

4.1 Notwithstanding anything elsewhere herein provided and in addition to any other right or remedy of NFL under the Contract or otherwise including right of NFL for compensation for delay the Engineer-in-charge/officer-in-charge may, without prejudice to his right against Consultant in respect of any delay, bad workmanship or otherwise or to any claims for damage in respect of any breaches of the Contract and without prejudice to any rights or remedies under any of the provisions of this Contract or otherwise and whether the date for completion has or has not elapsed by intimation in writing, absolutely, determine the Contract:

Default or failure by Contract of any of his obligations under the Contract including but not limited to the following, the Contract is liable to be terminated if the Consultant becomes bankrupt or insolvent or goes into liquidation or is ordered to be wound up or has a receiver appointed on its assets or execution or distress is levied upon all or substantially all of its assets.

-Abandons the work

Or

-Persistently disregards the instructions of the Owner in contravention of any provision of the Contract

Or

-Persistently fails to adhere to the agreed program of work

Or

-Sublets the work in whole or in part thereof without Owner consent in writing

Or

-Performance is not satisfactory or work is abnormally delayed

Or

-Defaults in the performance of any material undertaking under this Contract and fails to correct such default to the reasonable satisfaction of the Owner within fifteen days after written notice of such default is provided to the Contractor

Or

- Conceals or submit any false document or information furnished by the contractor regarding past experience and or contents of any document etc. are found false.

4.2 Owner may terminate the Contract due to any reason including reasons due to force majeure, regulations or ordinance of any Government or any other reasons beyond the reasonable control of the Owner.

Such termination will be by 15 (fifteen) days' notice in writing and no claim/compensation shall be payable by the Owner as a result of such termination, excepting the fees and costs for the meaningful services rendered by the Contractor and acceptable to Owner up to the date of termination.

4.3 CONSEQUENCES OF TERMINATION

If the contract is terminated by NFL for the reasons detailed under clause no. 4.1 of above or for any other reason whatsoever:

- i) NFL reserves the right to get the work completed at the risk and cost of the Contractor and to recover from the Contractor any amount by which the cost of completing the work by any other agency exceeds the value of the contract, without prejudice to any other remedies/rights/claims etc. that may be available with NFL.
- ii) Security Deposit/Performance Bank Guarantee Bond submitted by the Contractor shall stand forfeited.
- iii) The Contractor shall have no right to claim any compensation for any loss sustained by him by reason of his having entered into any commitment or made any advance on account of or with a view to the execution of the works, or on account of expected profits.
- iv) All the dues payable to the Contractor for the work executed by him before and up to termination shall only be released after making adjustments for the expenses, charges, damages and expected losses etc. incurred by NFL as a consequence of the termination of the contract.
- v) Apart from above NFL reserves the right to delist/ blacklist the contractor from the approved list of pre-qualified parties or debar from participating in tendering process of NFL in all units / offices as per NFL's rules & regulations.

ARTICLE-5

5.0 FORCE MAJEURE CLAUSE (FMC)

The terms and conditions agreed upon under the contract shall be subject to Force Majeure. Neither the contractor nor NFL shall be considered in default in the performance of their obligation contained therein, if such performance is prevented or delayed or restricted or interfered with by reason of War, Hostilities, Acts of Public Enemy, Civil Commotion, Strike, Lockouts, Epidemics/Pandemics, Accidents, Fires, Explosions, Flood, Earthquake, regulation or ordinance or requirement of any Government or any sub-division thereof or authority or representative of any such Govt., and/or due to technical snag/reasons or any other Act whatsoever, whether similar or dissimilar to those enumerated beyond the reasonable control of the parties hereto or because of any act of GOD. The party so affected, upon giving prompt notice to other party of such conditions and cause thereof from within 15(Fifteen) days of occurrence of such event, shall be excused from such performance to the extent of such prevention, delay, restriction or interference for the period it persists provided that the party so affected shall use its best efforts to avoid or remove such causes of non- performance if possible and shall continue performance hereunder with the utmost dispatch whenever such causes are removed.

If the performance in whole or in part of any obligation under this contract is prevented or delayed by reason of any such event for a period exceeding 90 (Ninety) days, either party may at its option terminate the contract by giving notice to the other party. For delays arising out of Force Majeure neither NFL nor the Contractor shall be liable to pay extra costs or to make good any losses incurred consequent to the happening of any of the event, provided it is mutually established that Force Majeure condition did actually exist.

ARTICLE-6

6.0 INDEMNITY BY CONTRACTOR

The Contractor shall indemnify and save harmless Owner from and against all actions, suit, proceedings, losses, costs, damages, charges, claims and demands of every nature and description brought or recovered against the Owner by reason of any act or omission of the Contractor, his agents or employees, in the execution of the works or in his guarding of

the same. All sums payable by way of compensation under any of these conditions shall be considered as reasonable compensation to be applied to the actual loss or damage sustained, and whether or not directly or indirectly any damage shall have been sustained.

ARTICLE-7

7.0 ENTIRE CONTRACT

The contract documents mentioned in Article-I hereof embody the entire contract between the parties hereto and the parties declare that in entering this contract, they do not rely upon any previous representation whether express or implied and whether written or oral or any inducement, understanding or agreement of any kind not included within the contract documents and all prior negotiations, representations contract and/or agreements and understanding are hereby cancelled.

ARTICLE-8

8.0 NOTICE

8.1 Subject to any provisions in the contract documents to the contrary, any notice, order of communication sought to be served by the Contractor on the Owner with reference to the contract shall be deemed to have been sufficiently served upon the Owner (notwithstanding any enabling provisions under any law to the contrary) only, if delivered by Hand or by Registered Post/ Speed Post or email to the Officer/Engineer-In-Charge as defined in the General Terms and Conditions of the contract.

8.2 Without prejudice to another mode of service provided for in the contract documents or otherwise available to the Owner, any notice, order or other communication sought to be served by the Owner on the Contractor with reference to the contract shall be deemed to have been sufficiently served upon the Contractor if delivered by Hand or through Registered Post/Speed Post or email to the Contractor at his specified address at_____.

ARTICLE- 9

9.0 WAIVER

9.1 No failure or delay by the Owner in enforcing any right or remedy of the Owner in terms of contract or any obligation or liability of the Contractor in terms thereof shall be deemed to be a waiver of such right, remedy, obligation or liability, as the case may be, by the Owner or notwithstanding such failure or delay, the Owner shall be entitled at any time to enforce such right remedy, obligation or liabilities as the case may be.

ARTICLE-10

10.0 NON-ASSIGNABILITY

10.1 The contract and benefits and obligations thereof shall be strictly personal to the Contractor and shall not on any account be assignable or transferable by the Contractor, except without written prior permission of Owner.

ARTICLE-11

11.0 DISPUTE RESOLUTION

For Indian Parties

“Any dispute or difference whatsoever arising between the parties out of or relating to the construction, meaning, scope, operation or effect of this contract or the validity or the breach thereof shall be resolved amicably through negotiations by the Parties. A “Notice of Dispute” shall be given by the party seeking resolution of a dispute to other party. If the dispute is not resolved within Thirty (30) days from the notice, the dispute shall be referred to arbitration as per the procedure mentioned herein below:

A written notice shall be given by the contractor invoking arbitration to National Fertilizers Limited through Designated Authority(as mentioned in General Terms and Conditions).

Where the claim including determination of interest, if any, being claimed upto the date of commencement of arbitration does not exceed Rs. Five crore, the reference shall be made to a sole arbitrator. The parties shall mutually agree on the name of sole arbitrator. In case of disagreement upon the name of the sole arbitrator, the appointment of Sole Arbitrator shall be done in accordance with the provisions of Arbitration & Conciliation Act, 1996.

Where the claim including determination of interest, if any, being claimed, upto the date of commencement of arbitration exceeds Rs. Five crore, the reference shall be made to arbitral tribunal consisting of three arbitrators. Each party shall nominate one arbitrator each within 30 days from the date of receipt of notice of invocation of arbitration and two nominated arbitrators shall appoint the presiding arbitrator within 30 days thereafter. If a Party to the dispute refuses or neglects to nominate an arbitrator on its behalf within the period specified, or the two arbitrators fails to nominate Presiding arbitrator, appointment of Arbitrator(s) shall be done in accordance with the provisions of Arbitration & Conciliation Act, 1996.

The Arbitration proceeding shall be governed by the Arbitration & Conciliation Act,1996 and any further statutory modification or re-enactment thereof and the rules made thereunder.

It is agreed by and between the parties that in case a reference is made to the Arbitrator for the purpose of resolving the disputes/differences arising out of the contract by and between the parties hereto, the Arbitrator shall not award interest on the awarded amount more than the rate SBI PLR/Base Rate applicable to NFL on date of award of contract.

The seat and venue of arbitration shall be Delhi/Place of respective Unit/Place of Zonal Office.

The cost of the proceedings shall be equally borne by the parties, unless otherwise directed by the arbitral tribunal. The decision of the arbitral tribunal shall be final and binding on all parties.”

11.1 For Foreign Parties

“Any dispute arising out of or in connection with this contract, including any question regarding its existence, validity or termination, shall be referred to and finally resolved by arbitration administered by the Singapore International Arbitration Centre (“SIAC”) in accordance with the Arbitration Rules of the Singapore International Arbitration Centre (“SIAC Rules”) for the time being in force, which rules are deemed to be incorporated by reference in this clause.

The seat and venue of the arbitration shall be at New Delhi, India.

The language of the arbitration shall be English.

This Contract/LOI/NIT shall be governed by and construed in accordance with the Laws of India.”

11.2 For CPSEs and Government Department

In the event of any dispute or difference relating to the interpretation and application of the provisions of commercial contract(s) between Central Public Sector Enterprises (CPSEs)/ Port Trusts inter se and also between CPSEs and Government Departments/Organizations (Other than those related to taxation), such dispute or difference shall be taken up by either party for resolution through AMRCD as mentioned in DPE OM No. 4(1)/2013-DPE(GM)/FTS-1835 dated 22-05-2018.

ARTICLE-12

12.0 JURISDICTION

Notwithstanding any other Court or Courts having Jurisdiction to decide the question(s) forming the subject matter of the reference, if the same had been the subject matter of a suit, any and all actions and proceedings arising out of or relative to the contract (including any arbitration in terms thereof) shall lie only in the court of Competent Civil Jurisdiction in this behalf at _____ (where this contract has been signed on behalf of the Owner) and only the said Court(s) shall have jurisdiction to entertain and try such action(s) and/or proceeding(s) to the exclusion of all other Courts.

IN WITNESS WHEREOF the parties hereto have duly executed this Contract in duplicate at the place, day and year first above written.

SIGNED & DELIVERED

For and on behalf of
National Fertilizers Ltd,
(Owner)
(With Rubber Stamp)

Date:
Place: Place:
In the Presence of:
Witness

1. Signature _____
Name of Signatory _____
Address _____
2. Signature _____
Name of Signatory _____

SIGNED & DELIVERED

For and on behalf of contractor

(With Rubber Stamp)

Date:

In the Presence of:
Witness

1. Signature _____
Name of Signatory _____
Address _____
2. Signature _____
Name of Signatory _____

NO CLAIM CERTIFICATE

Sub: Contract Agreement No. Dated..... for the Work of Fabrication & Erection of New Inter-connection Line (Suction, Extraction, Discharge, ARC By-pass Line, Balancing Line & Utility Lines) for installation of New BFW Pump at NFL, Panipat..

We have received the sum of Rs. (Rupees only) in full and final settlement of all the payments due to us under the above-mentioned contract agreement, between us and National Fertilizers Limited (NFL). We hereby unconditionally, and without any reservation whatsoever, certify that with this payment, we shall have no claim whatsoever, of any description, on any account, against NFL, against aforesaid contract agreement executed by us. We further declare unequivocally, that with this payment, we have received all the amounts payable to us, and have no dispute of any description whatsoever, regarding the amounts worked out as payable to us and received by us, and that we shall continue to be bound by the terms and conditions of the contract agreement, as regards performance of the contract.

Yours faithfully,

Signatures of contractor or officer authorized to
sign the contract documents on behalf of the contractor

(Company stamp)

Date:

Place:

CISF GATE PASS CLEARANCE

Certified that M/s. _____ have deposited gate passes issued against work order No. _____ dated _____ for _____ (Name of the work). All gate passes have been deposited by the contractor. Nothing is outstanding against this party as far as this work order is concerned.

Seal & Signature of the CISF Authority

Preference to Make in India

To encourage 'Make in India' and promote manufacturing and production of goods and services in India with a view to enhancing income and employment, Department of Promotion of Industry and Internal Trade (DPIIT), Ministry of Commerce and Industry, Government of India, issued Public Procurement (Preference to Make in India), Order 20171. The order is issued pursuant to Rule 153 (iii) of GFR, 2017. The Order is applicable on the procurement of Goods, Works and Services. For the purpose of this Order:-

- a) '*L1*' means the lowest tender or lowest bid or the lowest quotation received in a tender, bidding process or other procurement solicitation as adjudged in the evaluation process as per the tender or other procurement solicitation.
- b) '*Margin of purchase preference*' means the maximum extent to which the price quoted by a "Class-I local supplier" may be above the L1 for the purpose of purchase preference. It has been fixed as 20 (twenty) percent.
- c) '*Nodal Ministry*' means the Ministry or Department identified pursuant to this order in respect of a particular item of goods or services or works.
- d) '*Procuring entity*' means a Ministry or department or attached or subordinate office of, or autonomous body controlled by, the Government of India and includes Government companies as defined in the Companies Act.
- e) '*Works*' means all works as per Rule 130 of GFR- 2017, and will also include '*turnkey works*'.

i) Eligibility of 'Class-I local supplier'/'Class-II local supplier'/'non-local suppliers' for different types of procurement.

- a) In procurement of all goods, services or works in respect of which the Nodal ministry/Department has communicated that there is sufficient local capacity and local competition, only 'Class-I local supplier', shall be eligible to bid irrespective of purchase value.
- b) Only 'Class-I local supplier' and 'Class-II local supplier', shall be eligible to bid in procurements undertaken by procuring entities, except when Global tender enquiry has been issued. In global tender enquiries, 'Non-local suppliers' shall also be eligible to bid along with 'Class-I local suppliers' and 'Class-II local suppliers'. In procurement of all goods, services or works, not covered by sub-para (i)(a) above, and with estimated value of purchases less than Rs. 200 Crore, in accordance with Rule 161(iv) of GFR, 2017, Global tender enquiry shall not be issued except with the approval of competent authority as designated by Department of Expenditure.
- c) For the purpose of this Order, works includes Engineering, Procurement and Construction (EPC) contracts and services include System Integrator (SI) contracts.

ii) Purchase Preference

- a) Subject to the provisions of the Order and to any specific instructions issued by the Nodal Ministry or in pursuance of the Order, purchase preference shall be given to 'Class-I local supplier' in procurements undertaken by procuring entities in the manner specified here under.

- b) In the procurements of goods or works, which are covered by para (i) (b) above and which are divisible in nature, the ‘Class-I local supplier’ shall get purchase preference over ‘Class-II local supplier’ as well as ‘Non-local supplier’, as per following procedure:
1. Among all qualified bids, the lowest bid will be termed as L1. If L1 is ‘Class-I local supplier’, the contract for full quantity will be awarded to L1.
 2. If L1 bid is not a ‘Class-I local supplier’, 50 (fifty) percent of the order quantity shall be awarded to L1. Thereafter, the lowest bidder among the ‘Class-I local supplier’ will be invited to match the L1 price for the remaining 50 (fifty) percent quantity subject to the Class-I local supplier’s quoted price falling within the margin of purchase preference, and contract for that quantity shall be awarded to such ‘Class-I local supplier’ subject to matching the L1 price. In case such lowest eligible ‘Class-I local supplier’ fails to match the L1 price or accepts less than the offered quantity, the next higher ‘Class-I local supplier’ within the margin of purchase preference shall be invited to match the L1 price for remaining quantity and so on, and contract shall be awarded accordingly. In case some quantity is still left uncovered on Class-I local suppliers, then such balance quantity may also be ordered on the L1 bidder.
- c) In the procurements of goods or works, which are covered by para (i)(b) above and which are not divisible in nature, and in procurement of services where the bid is evaluated on price alone, the ‘Class-I local supplier’ shall get purchase preference over ‘Class-II local supplier’ as well as ‘Non-local supplier’, as per following procedure:
1. Among all qualified bids, the lowest bid will be termed as L1. If L1 is ‘Class-I local supplier’, the contract will be awarded to L1.
 2. If L1 is not ‘Class-I local supplier’, the lowest bidder among the ‘Class-I local supplier’, will be invited to match the L1 price subject to Class-I local supplier’s quoted price falling within the margin of purchase preference, and the contract shall be awarded to such ‘Class-I local supplier’ subject to matching the L1 price.
 3. In case such lowest eligible ‘Class-I local supplier’ fails to match the L1 price, the ‘Class-I local supplier’ with the next higher bid within the margin of purchase preference shall be invited to match the L1 price and so on and contract shall be awarded accordingly. In case none of the ‘Class-I local supplier’ within the margin of purchase preference matches the L1 price, the contract may be awarded to the L1 bidder.
 4. “Class-II local supplier” will not get purchase preference in any procurement, undertaken by procuring entities.

iii) Applicability in tenders where contract is to be awarded to multiple bidders

In tenders where contract is awarded to multiple bidders subject to matching of L1 rates or otherwise, the ‘Class-I local supplier’ shall get purchase preference over ‘Class-II local supplier’ as well as ‘Non-local supplier’, as per following procedure:

- a) In case there is sufficient local capacity and competition for the item to be procured, as notified by the nodal Ministry, only Class I local suppliers shall be eligible to bid. As such, the multiple suppliers, who would be awarded the contract, should be all and only ‘Class I Local suppliers’.
- b) In other cases, ‘Class II local suppliers’ and ‘Non local suppliers’ may also participate in the bidding process along with ‘Class I Local suppliers’ as per provisions of the Order.
- c) If ‘Class I Local suppliers’ qualify for award of contract for at least 50 (fifty) percent of the tendered quantity in any tender, the contract may be awarded to all the qualified bidders as per award criteria stipulated in the bid documents. However, in case ‘Class I Local suppliers’ do not qualify for award

of contract for at least 50 (fifty) percent of the tendered quantity, purchase preference should be given to the 'Class I local supplier' over 'Class II local suppliers'/ 'Non local suppliers' provided that their quoted rate falls within 20 (twenty) percent margin of purchase preference of the highest quoted bidder considered for award of contract so as to ensure that the 'Class I Local suppliers' taken in totality are considered for award of contract for at least 50 (fifty) percent of the tendered quantity.

- d) First purchase preference has to be given to the lowest quoting 'Class-I local supplier', whose quoted rates fall within 20 (twenty) percent margin of purchase preference, subject to its meeting the prescribed criteria for award of contract as also the constraint of maximum quantity that can be sourced from any single supplier. If the lowest quoting 'Class-I local supplier', does not qualify for purchase preference because of aforesaid constraints or does not accept the offered quantity, an opportunity may be given to next higher 'Class-I local supplier', falling within 20 (twenty) percent margin of purchase preference, and so on.
 - e) To avoid any ambiguity during bid evaluation process, the procuring entities may stipulate its own tender specific criteria for award of contract amongst different bidders including the procedure for purchase preference to 'Class-I local supplier' within the broad policy guidelines stipulated in sub-paras above.
- iv) **Exemption of small purchases:** Notwithstanding anything contained in paragraph (i), procurements where the estimated value to be procured is less than Rs. 5 lakhs shall be exempt from the Order. However, it shall be ensured by procuring entities that procurement is not split for the purpose of avoiding the provisions of this Order.
- v) **Minimum local content:** The 'local content' requirement to categorize a supplier as 'Class-I local supplier' is minimum 50 (fifty) percent. For 'Class-II local supplier', the 'local content' requirement is minimum 20 (twenty) percent. Nodal Ministry/Department may prescribe only a higher percentage of minimum local content requirement to categorize a supplier as 'Class-I local supplier'/ 'Class-II local supplier'. For the items, for which Nodal Ministry/ Department has not prescribed higher minimum local content notification under the Order, it shall be 50 (fifty) percent and 20 (twenty) percent for 'Class-I local supplier'/ 'Class-II local supplier' respectively.
- vi) **Requirement for specification in advance:** The minimum local content, the margin of purchase preference and the procedure for preference to Make in India shall be specified in the notice inviting tenders or other form of procurement solicitation and shall not be varied during a particular procurement transaction.
- vii) **Government E-marketplace:** In respect of procurement through the Government E-marketplace (GeM) shall, as far as possible, specifically mark the items which meet the minimum local content while registering the item for display, and shall, wherever feasible, make provision for automated comparison with purchase preference and without purchase preference and for obtaining consent of the local supplier in those cases where purchase preference is to be exercised.
- viii) **Verification of local content:**
- a) The 'Class-I local supplier'/ 'Class-II local supplier' at the time of tender, bidding or solicitation shall be required to indicate percentage of local content and provide self-certification that the item offered meets the local content requirement for 'Class- I local supplier'/ 'Class-II local supplier', as

the case may be. They shall also give details of the location(s) at which the local value addition is made.

- b) In cases of procurement for a value in excess of Rs. 10 crores, the 'Class-I local supplier'/'Class-II local supplier' shall be required to provide a certificate from the statutory auditor or cost auditor of the company (in the case of companies) or from a practicing cost accountant or practicing chartered accountant (in respect of suppliers other than companies) giving the percentage of local content.
- c) Decisions on complaints relating to implementation of this Order shall be taken by the competent authority which is empowered to look into procurement-related complaints relating to the procuring entity.
- d) Nodal Ministries may constitute committees with internal and external experts for independent verification of self-declarations and auditor's/ accountant's certificates on random basis and in the case of complaints.
- e) Nodal Ministries and procuring entities may prescribe fees for such complaints.
- f) False declarations will be in breach of the Code of Integrity under Rule 175(1)(i)(h) of the General Financial Rules for which a bidder or its successors can be debarred for up to two years as per Rule 151 (iii) of the General Financial Rules along with such other actions as may be permissible under law.
- g) A supplier who has been debarred by any procuring entity for violation of the Order shall not be eligible for preference under the Order for procurement by any other procuring entity for the duration of the debarment. The debarment for such other procuring entities shall take effect prospectively from the date on which it comes to the notice of other procurement entities, in the manner prescribed under paragraph (h) below.
- h) The Department of Expenditure shall issue suitable instructions for the effective and smooth operation of this process, so that:
 1. The fact and duration of debarment for violation of the Order by any procuring entity are promptly brought to the notice of the Member-Convenor of the Standing Committee and the Department of Expenditure through the concerned Ministry/Department or in some other manner;
 2. on a periodical basis such cases are consolidated and a centralized list or decentralized lists of such suppliers with the period of debarment is maintained and displayed on website(s);
 3. in respect of procuring entities other than the one which has carried out the debarment, the debarment takes effect prospectively from the date of uploading on the website(s) in the such a manner that ongoing procurements are not disrupted.

ix) Specifications in Tenders and other procurement solicitations:

- a) Every procuring entity shall ensure that the eligibility conditions in respect of previous experience fixed in any tender or solicitation do not require proof of supply in other countries or proof of exports.
- b) Procuring entities shall endeavour to see that eligibility conditions, including on matters like turnover, production capability and financial strength do not result in unreasonable exclusion of 'Class-I local supplier'/'Class-II local supplier' who would otherwise be eligible, beyond what is essential for ensuring quality or creditworthiness of the supplier.
- c) Procuring entities shall review all existing eligibility norms and conditions with reference to sub-paragraphs (viii) (a) and (b) above.

d) Reciprocity Clause

1. When a Nodal Ministry/Department identifies that Indian suppliers of an item are not allowed to participate and/ or compete in procurement by any foreign government, due to restrictive tender conditions which have direct or indirect effect of barring Indian companies such as registration in the procuring country, execution of projects of specific value in the procuring country etc., it shall provide such details to all its procuring entities including CMDs/CEOs of PSEs/PSUs, State Governments and other procurement agencies under their administrative control and GeM for appropriate reciprocal action.
 2. Entities of countries which have been identified by the nodal Ministry/Department as not allowing Indian companies to participate in their Government procurement for any item related to that nodal Ministry shall not be allowed to participate in Government procurement in India for all items related to that nodal Ministry/Department, except for the list of items published by the Ministry/ Department permitting their participation.
 3. The stipulation in (2) above shall be part of all tenders invited by the Central Government procuring entities stated in (1) above. All purchases on GeM shall also necessarily have the above provisions for items identified by nodal Ministry/Department.
 4. State Governments should be encouraged to incorporate similar provisions in their respective tenders.
 5. The term 'entity' of a country shall have the same meaning as under the FDI Policy of DPIIT as amended from time to time.
- e) Specifying foreign certifications/ unreasonable technical specifications/ brands/models in the bid document is restrictive and discriminatory practice against local suppliers. If foreign certification is required to be stipulated because of nonavailability of Indian Standards and/or for any other reason, the same shall be done only after written approval of Secretary of the Department concerned or any other Authority having been designated such power by the Secretary of the Department concerned.
- f) “All administrative Ministries/Departments whose procurement exceeds Rs. 1000.Crore per annum shall notify/ update their procurement projections every year, including those of the PSEs/PSUs, for the next 5 years on their respective website.”
- x) **Action for non-compliance of the Provisions of the Order:** In case restrictive or discriminatory conditions against domestic suppliers are included in bid documents, an inquiry shall be conducted by the Administrative Department undertaking the procurement (including procurement by any entity under its administrative control) to fix responsibility for the same. Thereafter, appropriate action, administrative or otherwise, shall be taken against erring officials of procurement entities under relevant provisions. Intimation on all such actions shall be sent to the Standing Committee.
- xi) **Assessment of supply base by Nodal Ministries:** The Nodal Ministry shall keep in view the domestic manufacturing / supply base and assess the available capacity and the extent of local competition while identifying items and prescribing the higher minimum local content or the manner of its calculation, with a view to avoiding cost increase from the operation of this Order.
- xii) **Increase in minimum local content:** The Nodal Ministry may annually review the local content requirements with a view to increasing them, subject to availability of sufficient local competition with adequate quality.

xiii) **Manufacture under license/ technology collaboration agreements with phased indigenization**

- a) While notifying the minimum local content, Nodal Ministries may make special provisions for exempting suppliers from meeting the stipulated local content if the product is being manufactured in India under a license from a foreign manufacturer who holds intellectual property rights and where there is a technology collaboration agreement / transfer of technology agreement for indigenous manufacture of a product developed abroad with clear phasing of increase in local content.
- b) In procurement of all goods, services or works in respect of which there is substantial quantity of public procurement and for which the nodal ministry has not notified that there is sufficient local capacity and local competition, the concerned nodal ministry shall notify an upper threshold value of procurement beyond which foreign companies shall enter into a joint venture with an Indian company to participate in the tender. Procuring entities, while procuring such items beyond the notified threshold value, shall prescribe in their respective tenders that foreign companies may enter into a joint venture with an Indian company to participate in the tender. The procuring Ministries/Departments shall also make special provisions for exempting such joint ventures from meeting the stipulated minimum local content requirement, which shall be increased in a phased manner.

xiv) **Powers to grant exemption and to reduce minimum local content:** The administrative Department undertaking the procurement (including procurement by any entity under its administrative control), with the approval of their Minister-incharge, may by written order, for reasons to be recorded in writing,

1. reduce the minimum local content below the prescribed level; or
2. reduce the margin of purchase preference below 20 (twenty) percent; or
3. exempt any particular item or supplying entities from the operation of this Order or any part of the Order.

A copy of every such order shall be provided to the Standing Committee and concerned Nodal Ministry / Department. The Nodal Ministry / Department concerned will continue to have the power to vary its notification on Minimum Local Content.

xv) **Directions to Government companies:** In respect of Government companies and other procuring entities not governed by the General Financial Rules, the administrative Ministry or Department shall issue policy directions requiring compliance with this Order.

xvi) **Standing Committee.** A standing committee is hereby constituted with the following membership: Secretary, Department for Promotion of Industry and Internal Trade-Chairman Secretary, Commerce-Member Secretary, Ministry of Electronics and Information Technology-Member Joint Secretary (Public Procurement), Department of Expenditure-Member Joint Secretary (DPIIT)-Member-Convenor. The Secretary of the Department concerned with a particular item shall be a member in respect of issues relating to such item. The Chairman of the Committee may co-opt technical experts as relevant to any issue or class of issues under its consideration.

xvii) **Removal of difficulties:** Ministries /Departments and the Boards of Directors of Government companies may issue such clarifications and instructions as may be necessary for the removal of any difficulties arising in the implementation of the Order.

xviii) **Ministries having existing policies:** Where any Ministry or Department has its own policy for preference to local content approved by the Cabinet after 1st January 2015, such policies will prevail over

the provisions of the Order. All other existing orders on preference to local content shall be reviewed by the Nodal Ministries and revised as needed to conform to this Order, within two months of the issue of this Order.

xix) **Transitional provision:** The Order shall not apply to any tender or procurement for which notice inviting tender or other form of procurement solicitation has been issued before the issue of this Order. (Rule 153 of GFR 2017) (Note: 1 Latest revision to the Order notified vide OM No. P-45021/2/2017-PP (BEII) issued by DPIIT, dated 16.09.2020)

[Buyer is advised to refer latest guidelines, if any, issued by the Ministry/ Corporate Office].

Model Clauses for Tenders

- I. Any bidder from a country which shares a land border with India will be eligible to bid in this tender only if the bidder is registered with the Competent Authority.
- II. “Bidder” (including the term ‘tenderer’, ‘consultant’ or ‘service provider’ in certain contexts) means any person or firm or company, including any member of a consortium or joint venture (that is an association of several persons, or firms or companies), every artificial juridical person not falling in any of the descriptions of bidders stated hereinbefore, including any agency branch or office controlled by such person, participating in a procurement process.
- III. “Bidder from a country which shares a land border with India” for the purpose of this Order means:
 - a. An entity incorporated, established or registered in such a country; or
 - b. A subsidiary of an entity incorporated, established or registered in such a country; or
 - c. An entity substantially controlled through entities incorporated, established or registered in such a country; or
 - d. An entity whose beneficial owner is situated in such a country; or
 - e. An Indian (or other) agent of such an entity; or
 - f. A natural person who is a citizen of such a country; or
 - g. A consortium or joint venture where any member of the consortium or joint venture falls under any of the above.
- IV. The beneficial owner for the purpose of (iii) above will be as under:
 1. In case of a company or Limited Liability Partnership, the beneficial owner is the natural person(s), who, whether acting alone or together, or through one or more juridical person, has a controlling ownership interest or who exercises control through other means.

Explanation—

- a. “Controlling ownership interest” means ownership of or entitlement to more than twenty-five per cent, of shares or capital or profits of the company;
 - b. “Control” shall include the right to appoint majority of the directors or to control the management or policy decisions including by virtue of their shareholding or management rights or shareholders agreements or voting agreements;
2. In case of a partnership firm, the beneficial owner is the natural person(s) who, whether acting alone or together, or through one or more juridical person, has ownership of entitlement to more than fifteen percent of capital or profits of the partnership;
 3. In case of an unincorporated association or body of individuals, the beneficial owner is the natural person(s), who, whether acting alone or together, or through one or more juridical person, has ownership of or entitlement to more than fifteen percent of the property or capital or profits of such association or body of individuals;

4. Where no natural person is identified under (1) or (2) or (3) above, the beneficial owner is the relevant natural person who holds the position of senior managing official;

5. In case of a trust, the identification of beneficial owner(s) shall include identification of the author of the trust, the trustee, the beneficiaries with fifteen percent or more interest in the trust and any other natural person exercising ultimate effective control over the trust through a chain of control or ownership.

V. An Agent is a person employed to do any act for another, or to represent another in dealings with third person.

VI. [To be inserted in tenders for Works contracts, including Turnkey contracts] The successful bidder shall not be allowed to sub-contract works to any contractor from a country which shares a land border with India unless such contractor is registered with the Competent Authority. Model Certificate for Tenders (for transitional cases as stated in para 3 of this Order).

"I have read the clause regarding restrictions on procurement from a bidder of a country which shares a land border with India; I hereby certify that this bidder is not from such a country and is eligible to be considered."

Model Certificate for Tenders

"I have read the clause regarding restrictions on procurement from a bidder of a country which shares a land border with India; I certify that this bidder is not from such a country or, if from such a country, has been registered with the Competent Authority. I hereby certify that this bidder fulfills all requirements in this regard and is eligible to be considered. [Where applicable, evidence of valid registration by the Competent Authority shall be attached.]"

Model Certificate for Tenders for Works involving possibility of sub-contracting:

"I have read the clause regarding restrictions on procurement from a bidder of a country which shares a land border with India and on sub-contracting to contractors from such countries; I certify that this bidder is not from such a country or, if from such a country, has been registered with the Competent Authority and will not subcontract any work to a contractor from such countries unless such contractor is registered with the Competent Authority. I hereby certify that this bidder fulfills all requirements in this regard and is eligible to be considered. [Where applicable, evidence of valid registration by the Competent Authority shall be attached.]"

Model Certificate for GeM:

"I have read the clause regarding restrictions on procurement from a bidder of a country which shares a land border with India; I certify that this vendor/ bidder is not from such a country or, is not from such a country, has been registered with the Competent Authority. I hereby certify that this vendor/ bidder fulfills all requirements in this regard and is eligible to be considered for procurement on GeM. [Where applicable, evidence of valid registration by the Competent Authority shall be attached.]"

[Buyer is advised to refer latest guidelines, if any, issued by the Ministry/ Corporate Office].

Public Procurement Policy for Micro and Small Enterprises (MSEs):

Reservation of specific items for procurement from Micro and Small Enterprises (MSE)

To enable wider dispersal of enterprises in the country, particularly in rural areas, the Central Government Ministries or Departments or Public Sector Undertakings shall continue to procure items reserved for procurement exclusively from MSE (presently 358 (three hundred and fifty-eight) items including eight items of Handicrafts) from Micro and Small Enterprises, which have been reserved for exclusive purchase from them. The latest list may be seen from the website of the MSME Ministry¹. Ministry of MSME has clarified that the laminated paper Gr.I,II and III are not covered under the paper conversion product (SI.No.202) of the Public Procurement Policy². For locating the sources of such reserved items, NSIC may be contacted.

Public Procurement Policy for Micro and Small Enterprises (MSEs)

- i) From time to time, the Government of India (Procuring Entity) lays down procurement policies to help inclusive national economic growth by providing long- term support to micro, small and medium enterprises and disadvantaged sections of society. The Procurement Policy for Micro and Small Enterprises, 2012 [amended 2018 and 2021] has been notified by the Government in exercise of the powers conferred in Section 11 of the Micro, Small and Medium Enterprises Development (MSMED) Act, 2006. Details of the policy along with the amendments issued in 2018 and 2021 are available on the MSME website³.
- ii) Micro and Small Enterprises (MSEs) registered under Udyam Registration are eligible to avail the benefits under the policy.
- iii) The Policy is applicable to all the Central Government Ministries/ Departments/ CPSUs.

However, the policy is not applicable to State Government Ministries/ Departments/ PSUs.

- 1) To reduce transaction cost of doing business, MSEs will be facilitated by providing them tender documents free of cost, exempting MSEs from payment of earnest money deposit, adopting e-procurement to bring transparency in tendering process. However, exemption from paying Performance Bank Guarantee is not covered under the policy. MSEs may also be given relaxation in prior turnover and prior experience criteria during the tender process, subject to meeting of quality and technical specifications.

However, there may be circumstances (like procurement of items related to public safety, health, critical security operations and equipment, etc.) where procuring entity may prefer the vendor to have prior experience rather than giving orders to new entities⁴.

- 2) Chapter V of the MSMED Act, 2006 also has provision for ensuring timely payments to the MSE suppliers. The period agreed upon for payment must not exceed forty-five days after the supplies. For delays in payment the buyer shall be liable to pay compound interest to the supplier on the delayed amount at three times of the bank rate notified by the Reserve Bank. For arbitration and conciliation

regarding recovery of such payments and interests, Micro and Small Enterprises Facilitation Council has been setup in states.

- 3) In tender, participating Micro and Small Enterprises (MSE) quoting price within price band of L1+15 (fifteen) per cent shall also be allowed to supply a portion of requirement by bringing down their price to L1 price in a situation where L1 price is from someone other than a MSE and such MSE shall be allowed to supply up to 25(twenty five) per cent of total tendered value. The 25(twenty five) per cent quantity is to be distributed proportionately among these bidders, in case there are more than one MSEs within such price band.
- 4) Within this 25% (Twenty Five Percent) quantity, a purchase preference of four (4) per cent is reserved for MSEs owned by Scheduled Caste (SC)/Scheduled Tribe (ST) entrepreneurs and three (3) percent is reserved for MSEs owned by women entrepreneur (if they participate in the tender process and match the L1 price). However, in event of failure of such MSEs to participate in tender process or meet tender requirements and L1 price, four percent sub-target for procurement earmarked for MSEs owned by SC/ST entrepreneurs and three (3) percent earmarked to women owned by SC/ ST entrepreneurs:
 - a) In case of proprietary MSE, proprietor(s) shall be SC /ST;
 - b) In case of partnership MSE, the SC/ ST partners shall be holding at least 51% (fifty-one percent) shares in the unit;
 - c) In case of Private Limited Companies, at least 51% (fifty-one percent) share shall be held by SC/ ST promoters.
- iv) If subcontract is given to MSEs, it will be considered as procurement from MSEs.
- v) In case of tender item cannot be split or divided, etc. the MSE quoting a price within the band L1+15% may be awarded for full/ complete supply of total tendered value to MSE, considering the spirit of the Policy for enhancing Govt. Procurement from MSEs.
- vi) To develop MSE vendors so as to achieve their targets for MSEs procurement, Central Government Ministries /Departments /PSUs shall take necessary steps to develop appropriate vendors by organizing Vendor Development Programmes (VDPs) or Buyer-Seller Meets focused on developing MSEs for procurement through the Government e-Marketplace (GeM) portal. In order to develop vendors belonging to MSEs for Public Procurement Policy, the Ministry of MSME is regularly organizing State Level VDPs and National Level VDPs under the Procurement and Marketing Support Scheme. For enhancing participation of MSEs owned by SCs/STs/ Women in Government procurement, Central Government Ministries/ Departments/ CPSUs have to take the following steps:
 - a) Special Vendor Development Programmes/ Buyer-Seller Meets would be conducted by Departments/ CPSUs for SC/STs and Women.
 - b) Outreach programmes will be conducted by National Small Industries Corporation (NSIC) to cover more and more MSEs from SC/STs under its schemes of consortia formation; and
 - c) NSIC would open a special window for SCs/ STs under its Single Point Registration Scheme (SPRS).
 - d) A National SC/ST hub scheme was launched in October, 2016, for providing handholding support to SC/ST entrepreneur which is being coordinated / implemented by the NSIC under this Ministry.

- vii) Where any Aggregator has been appointed by the Ministry of MSME, themselves quote on behalf of some MSE units, such offers will be considered as offers from MSE units and all such facilities would be extended to these also.
- viii) This Policy is meant for procurement of only goods produced and services rendered by MSEs. Traders/ distributors/ sole agent/ Works Contract are excluded from the purview of the policy.
- ix) **Exemptions from the policy:** Given their unique nature, defence armament imports shall not be included in computing 25(twenty five) per cent goal for Ministry of Defence.
In addition, defence equipments like weapon systems, missiles, etc. shall remain out of purview of such Policy of reservation. Monitoring of goals set under the policy will be done, in so far as they related to Defense sector, by Ministry of Defense itself in accordance with suitable procedures to be established by them.
- x) To monitor the progress of procurement by Central Government Ministries/Departments and CPSUs from MSEs, Ministry of MSME has launched the MSME ‘Sambandh’⁵ Portal on 8th December, 2017 for uploading procurement details by all CPSUs on a monthly and an annual basis which is regularly monitored by the Ministry.
- xi) To redress the grievances of MSEs related to non-compliance of the Policy a Grievance cell named “CHAMPION Portal” has been set up in the Ministry of MSME.

(Note: ¹ <http://www.dcmsme.gov.in/schemes/Listof358itemsReserved.pdf> ²

Policy Circular No. 21(6)/2016-MA dated 26.05.2016

³<http://dcmsme.gov.in/pppm.htm.aspx>

⁴Notified vide OM No.F.20/2/2014-PPD(Pt.) issued by Department of Expenditure dated 29.09.2016.

⁵https://sambandh.msme.gov.in/PPP_Index.aspx)

[Buyer is advised to refer latest guidelines, if any, issued by the Ministry/ Corporate Office].

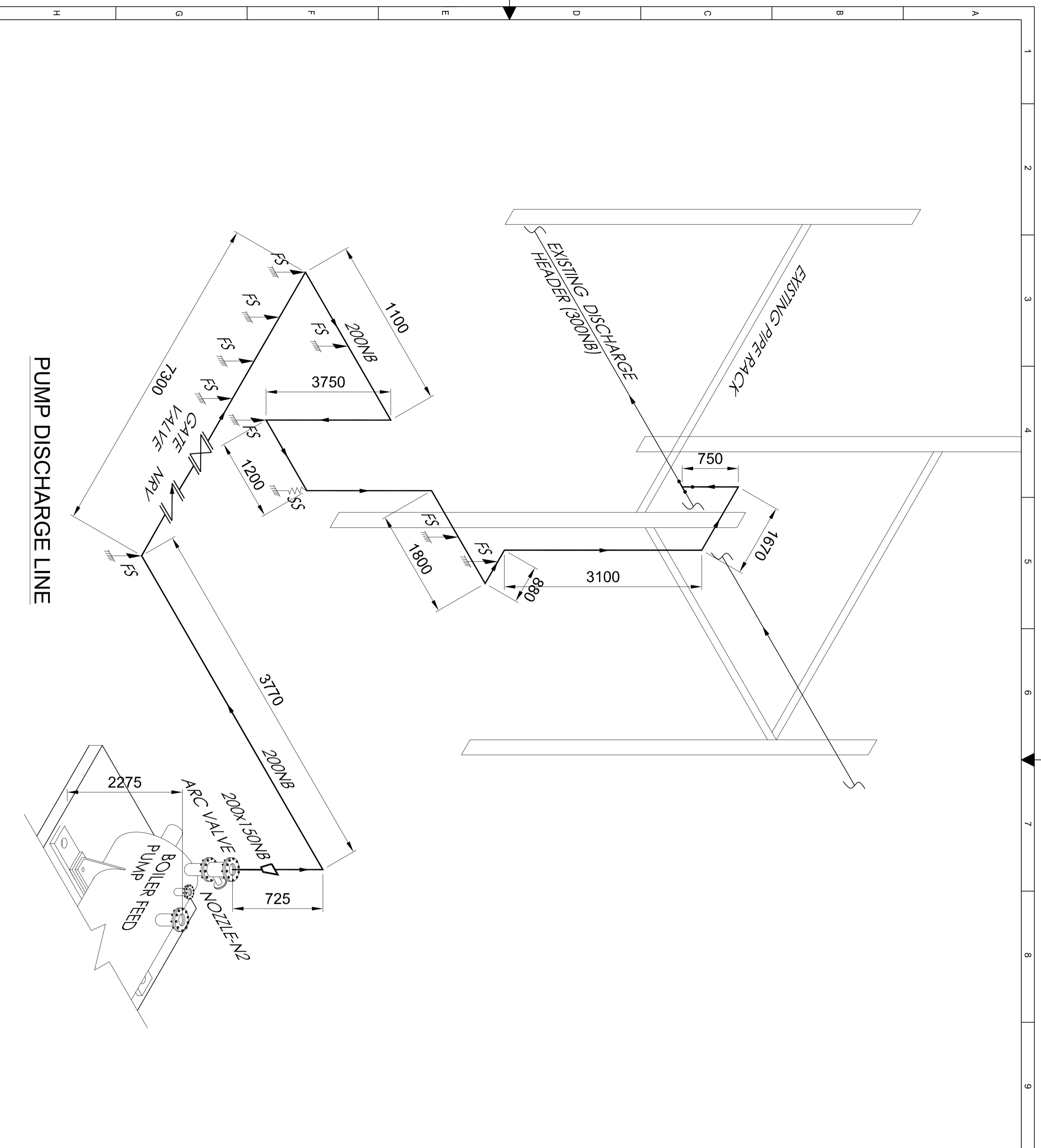

NOTES:

1. ALL DIMENSIONS ARE IN MM.
2. PIPE SUPPORTS & ITS SIZES TO BE DECIDE SUITABLY BY CLIENT.
3. SUPPORTS REQUIRED FOR PIPE ON PIPE RACK TO BE DECIDE SUITABLY AT SITE BY CLIENT.
4. PIPE PRESSURE & TEMPERATURE RATING :
SUCTION LINE : PRESSURE RATING = CLASS #300, TEMP. = 131 DEG.C
BALANCING LINE : PRESSURE RATING = CLASS #300, TEMP. = 131 DEG.C
DISCHARGE LINE : PRESSURE RATING = CLASS #500, TEMP. = 131 DEG.C
I/O LINE : PRESSURE RATING = CLASS #1500, TEMP. = 131 DEG.C
ARC BYPASS LINE : PRESSURE RATING = CLASS #1500, TEMP. = 131 DEG.C
5. PIPE MOC:-
PIPE MATERIAL: ASTM A106GR-B(SEAMLESS)
GASKET : RTJ-OCTAGONAL,ASME B16.20, SOFT IRON
BOLTING : ASTM A193 GR-B7 / ASTM A194 GR-2H
(ABOVE PIPING MOC IS CONSIDERED AS PER TECHNICAL SPECIFICATION DOCUMENT NUMBER D-5013-PBAM-PD-SF-0003)
6. FS= FIXED SUPPORT, SS = SPRING SUPPORT.
7. ALL PIPING SHALL BE PROVIDED WITH SUITABLE INSULATION & CLADDING.
8. SIZE OF STRAINER AT PUMP SUCTION LINE SHALL BE 300 NB.

BILL OF MATERIAL:

SR.NO.	ITEM NAME	SIZE	QTY.	UNIT
LOCATION: PUMP DISCHARGE SIDE				
1	PIPE	200 NB	40	MTR.
2	UNEQUAL TEE - 300NBx300NBx200NB	-	01	NO.
3	90° BEND	200 NB	15	NOS.
4	ISOLATION GATE VALVE	200 NB	01	NO.
5	NON RETURN VALVE	200 NB	01	NO.
6	EXPANDER (CONCENTRIC TYPE) - 200NBx150NBx200MM LONG	-	01	NO.

REFERENCE DRAWINGS:

KFO-501009901000100 | BOILER FEED PUMP GA DRAWING-R1
KEPL W/O NO. S050100990, PUMP TAG NO. AGA-701

PROJECT:
AMMONIA FEED STOCK
CHANGEOVER PROJECT, PANIPAT

OWNER:
NATIONAL FERTILIZERS LTD. INDIA

OWNER CONSULTANT:

CONTRACTOR:
 **KIRLOSKAR BROTHERS LIMITED, PUNE (INDIA)**

PURPOSE OF DRAWING:
FOR APPROVAL

NAME	DATE	TITLE:
SPU	16.06.2023	BOILER FEED PUMP
SDS	16.06.2023	PIPING ISOMETRIC DRAWING
DSS/SSP	16.06.2023	DWG. NO.: KBL/DE/KEPL/2202/NF/LME02

SCALE : NTS
SHEET NO.: 3 OF 3
REV. NO.: 02
SHEET SIZE : A2

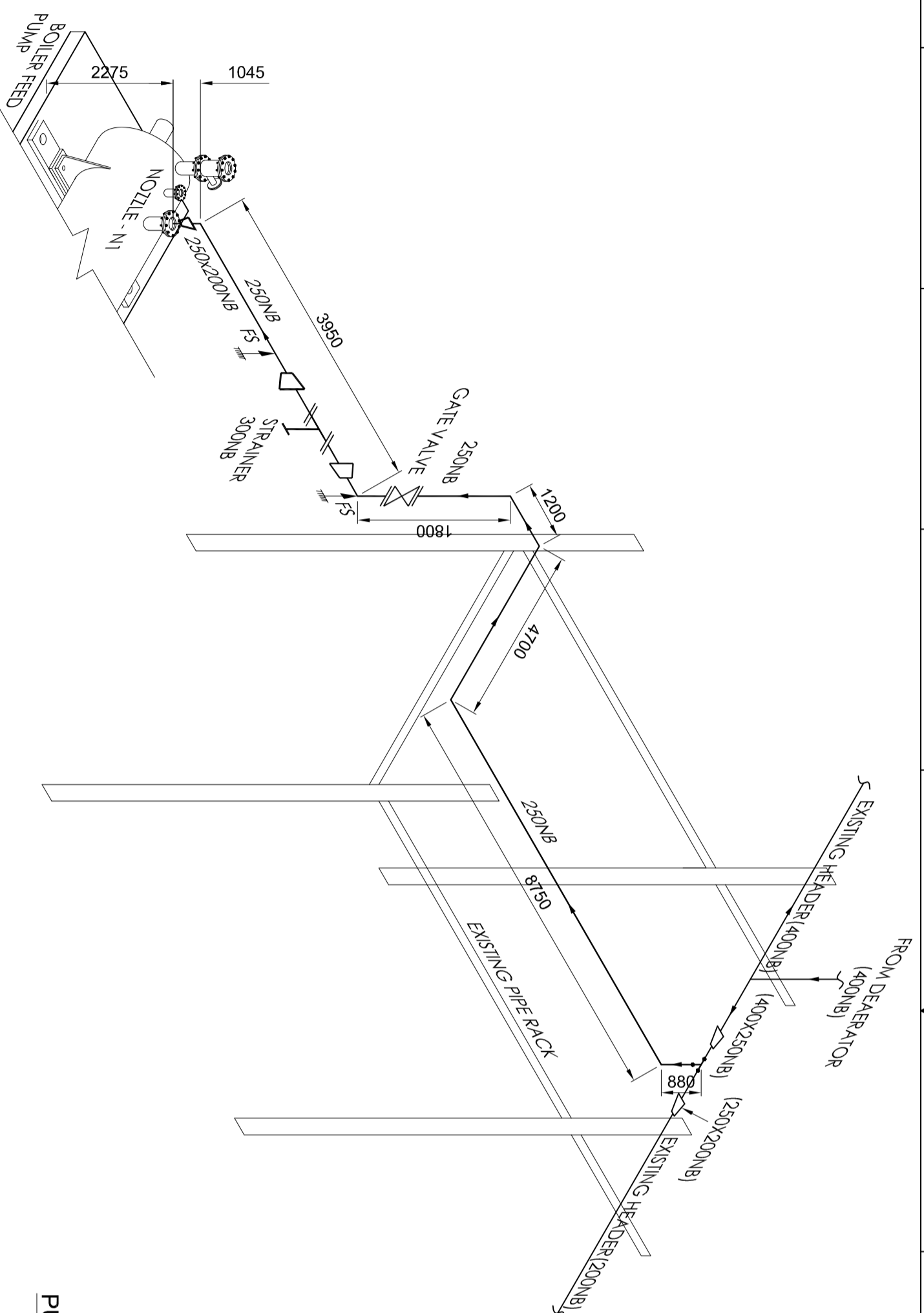

PUMP SUCTION LINE

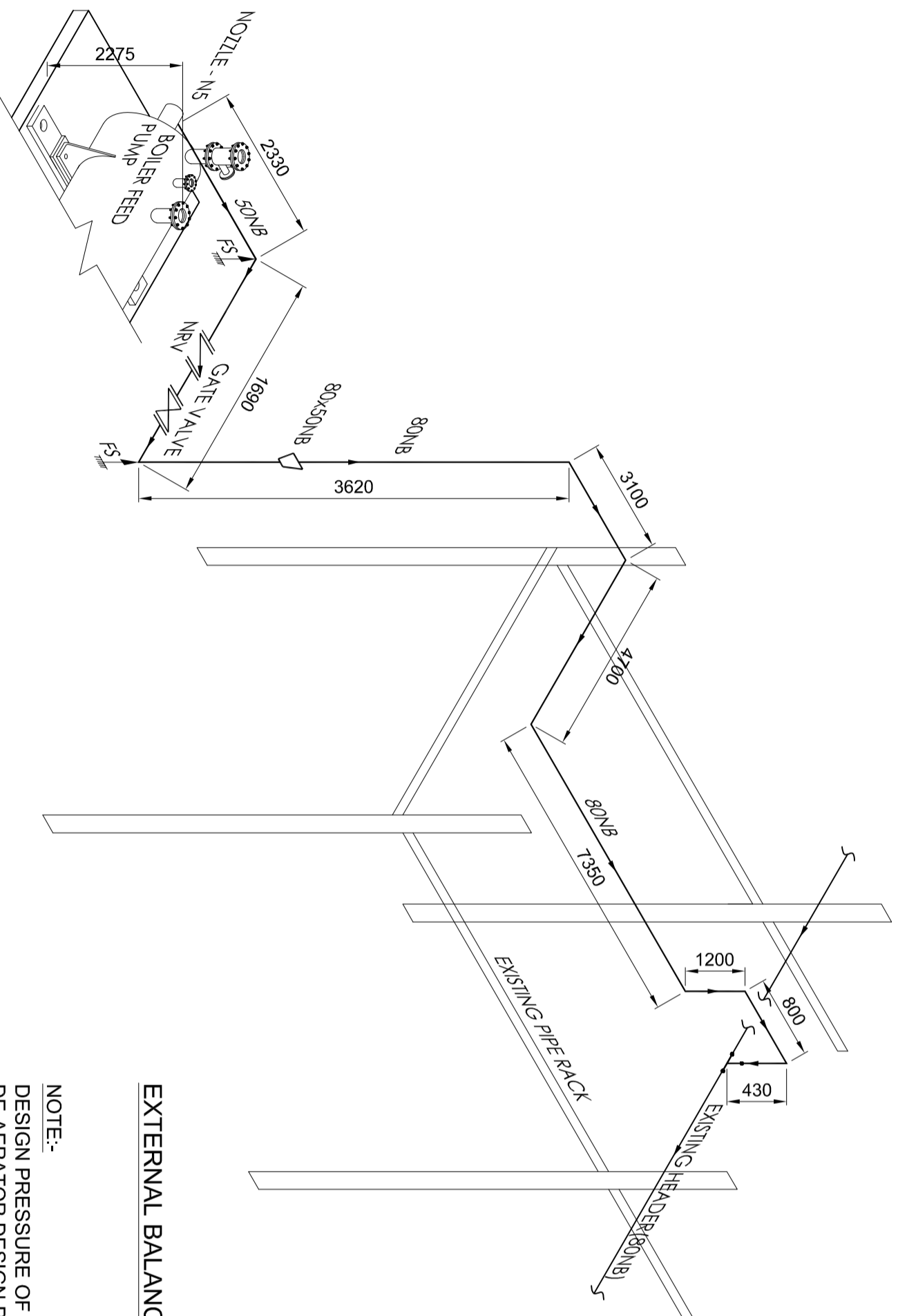

EXTERNAL BALANCING LINE

NOTE:-
DESIGN PRESSURE OF BALANCING LINE IS EQUAL TO
DE-AERATOR DESIGN PRESSURE i.e. 10kg/cm² @ 131° C

NOTES:

1. ALL DIMENSIONS ARE IN MM.
2. PIPE SUPPORTS & ITS SIZES TO BE DECIDE SUITABLY BY CLIENT.
3. SUPPORTS REQUIRED FOR PIPE ON PIPE RACK TO BE DECIDE SUITABLY AT SITE BY CLIENT.
4. PIPE PRESSURE & TEMPERATURE RATING :
SUCTION LINE : PRESSURE RATING = CLASS #300, TEMP = 131 DEG C
BALANCING LINE : PRESSURE RATING = CLASS #300, TEMP = 131 DEG C
DISCHARGE LINE : PRESSURE RATING = CLASS #1500, TEMP = 131 DEG C
I/O LINE : PRESSURE RATING = CLASS #1500, TEMP = 131 DEG C
ARC BYPASS LINE : PRESSURE RATING = CLASS #1500, TEMP = 131 DEG C
5. PIPE MOC:-
PIPE MATERIAL: ASTM A106GR-B(SEMILESS)
GASKET : RT-1, OCTAGONAL, ASME B16.20, SOFT IRON
BOLTING : ASTM A193 GR-B7 / ASTM A194 GR-2H
(ABOVE PIPING MOC IS CONSIDERED AS PER TECHNICAL SPECIFICATION
DOCUMENT NUMBER D-5013-PBAM-PD-SF-0003)
6. FS= FIXED SUPPORT, SS= SPRING SUPPORT.
7. ALL PIPING SHALL BE PROVIDED WITH SUITABLE INSULATION & CLADDING.
8. SIZE OF STRAINER AT PUMP SUCTION LINE SHALL BE 300 NB.

BILL OF MATERIAL:

S.R.NO.	ITEM NAME	SIZE	QTY.	UNIT
LOCATION: PUMP SUCTION SIDE				
1	PIPE	250 NB	35	MTR.
2	EQUAL TEE - 250NBx250NBx250NB	-	01	NO.
3	90° BEND	250 NB	08	NOS.
4	ISOLATION GATE VALVE	250 NB	01	NO.
5	STRAINER	300 NB	01	NO.
6	REDUCER (CONCENTRIC TYPE) -	-	01	NO.
7	REDUCER (CONCENTRIC TYPE) -	-	02	NOS.
8	EXPANDER (CONCENTRIC TYPE) -	-	01	NO.
9	REDUCER (CONCENTRIC TYPE) -	-	01	NO.

LOCATION: EXTERNAL BALANCING LINE

10	PIPE	50NB	10	MTR.
11	EQUAL TEE - 80NBx80NBx80NB	-	01	NO.
12	EXPANDER (CONCENTRIC TYPE) -	-	01	NO.
13	PIPE	80NB	35	MTR.
14	90° BEND	80NB	12	NOS.
15	ISOLATION GATE VALVE	50NB	01	NO.
16	NON RETURN VALVE	50NB	01	NO.

REFERENCE DRAWINGS:

KFO-501009901000100 | BOILER FEED PUMP GA DRAWING-R1
KEPL W/O NO. S050100990, PUMP TAG NO. AGA-701

REV.	DATE	DESCRIPTION	PREP.	CHKD.	APPD.
1	05.07.2023	UPDATED AS PER CLIENT COMMENTS	SPU	SDS	DSS
2	03.10.2023	UPDATED AS PER CLIENT COMMENTS	SPU	SDS	DSS

PROJECT: AMMONIA FEED STOCK
CHANGEOVER PROJECT, PANIPAT

OWNER: NATIONAL FERTILIZERS LTD. INDIA

OWNER CONSULTANT:

KIRLOSKAR BROTHERS
LIMITED, PUNE (INDIA)

CONTRACTOR:  KIRLOSKAR BROTHERS LIMITED, PUNE (INDIA)

PURPOSE OF DRAWING: FOR APPROVAL

NAME: BOILER FEED PUMP

DATE: 16.06.2023

TITLE: PIPING ISOMETRIC DRAWING

SPU: 16.06.2023

SDS: 16.06.2023

DSS/SSP: 16.06.2023

DWG. NO.: KBL/DE/KEPL/2202/NFL/ME02

SHEET NO.: 1 OF 3

REV. NO.: 02

SHEET SIZE : A2

SCALE : NTS

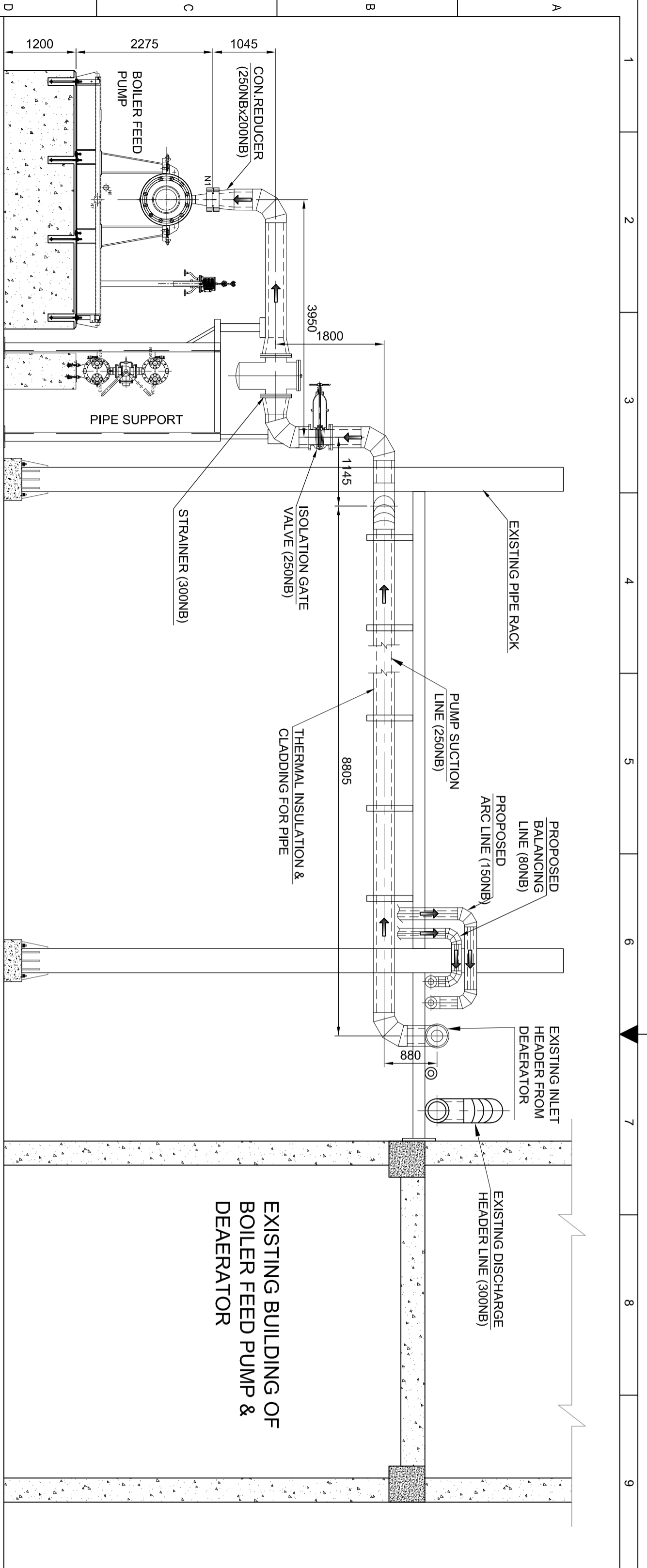

SECTION A-A
(SCALE :- 1:60)

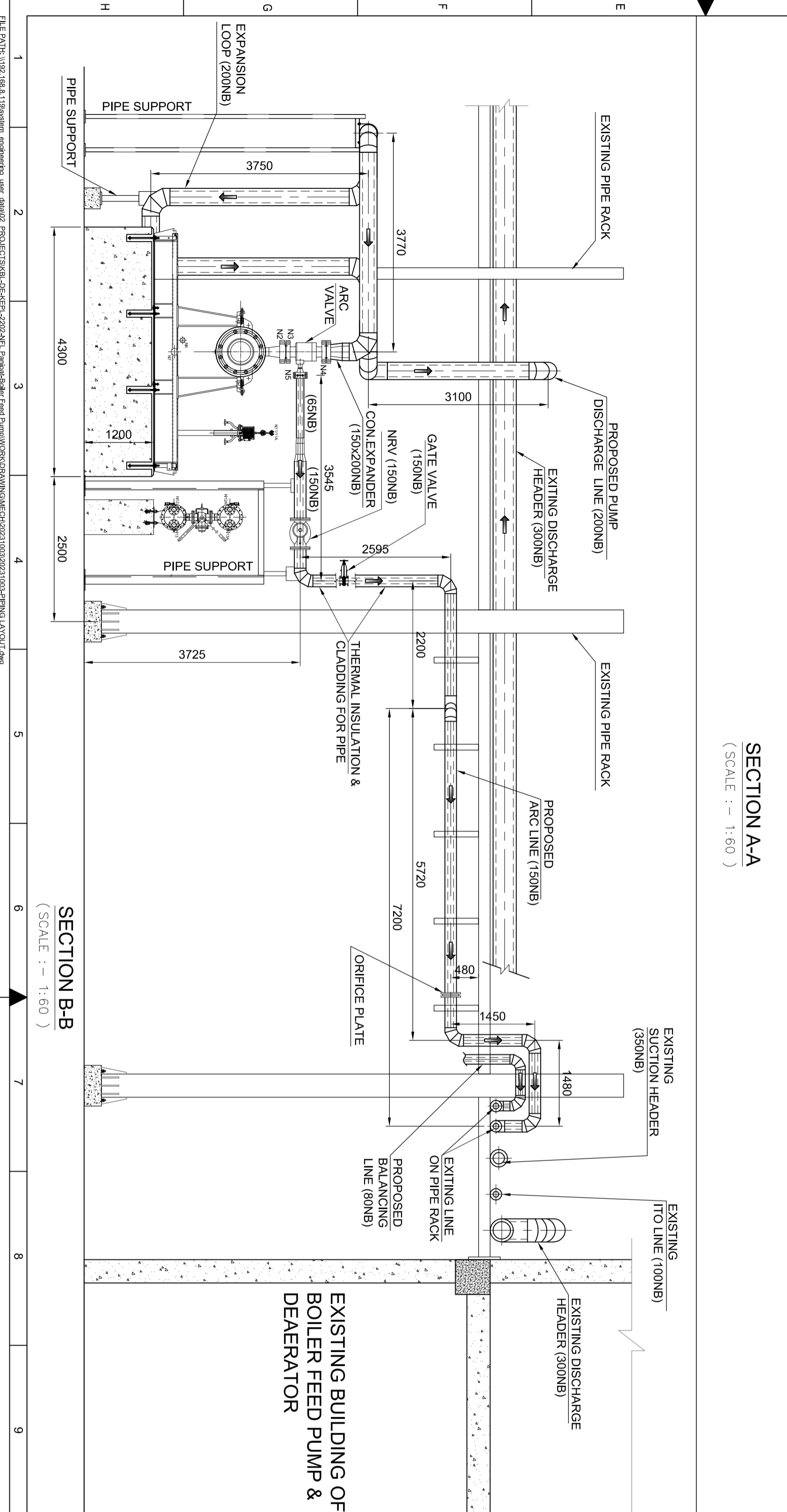

SECTION B-B
(SCALE :- 1:60)

**EXISTING BUILDING OF
BOILER FEED PUMP &
DEAERATOR**

**EXISTING BUILDING OF
BOILER FEED PUMP &
DEAERATOR**

- NOTES:**
1. ALL DIMENSIONS ARE IN MM.
 2. PIPE SUPPORTS & HANGERS TO BE DESIGNED SUITABLY BY CLIENT.
 3. SUPPORTS REQUIRED FOR PIPE ON PIPE RACK TO BE DESIGNED SUITABLY AT SITE BY CLIENT.
 4. PIPE PRESSURE & TEMPERATURE RATING :-
SUCTION LINE : PRESSURE RATING = CLASS #900, TEMP. = 131 DEG.C
DISCHARGE LINE : PRESSURE RATING = CLASS #900, TEMP. = 131 DEG.C
BALANCING LINE : PRESSURE RATING = CLASS #900, TEMP. = 131 DEG.C
ARC BYPASS LINE : PRESSURE RATING = CLASS #900, TEMP. = 131 DEG.C
PIPE MOC:-
 5. PIPE MATERIAL :-ASTM A106GR.B(SEAMLESS)
GASKET :- RULOCKONALUMINUM BRASS
(ABOVE PIPING MOC & CONSIDERED AS PER TECHNICAL SPECIFICATION DOCUMENT NUMBER D-501347BMA-P2-SF-0003)
 6. ALL PIPING SHALL BE PROVIDED WITH SUITABLE INSULATION & CLADDING.
 7. SIZE OF STRAINER AT PUMP SUCTION LINE SHALL BE 300 NB.
 8. OVER SIZE OF PARTICLES IN PROCESS WATER SHALL BE LOOSE SUPPLY INERT SCOPE & TO BE INSTALLED NEAR DEAERATOR.

BILL OF MATERIAL

SR.NO.	ITEM NAME	SIZE	QTY.	UNIT
LOCATION: PUMP SUCTION SIDE				
1	PIPE	250 NB	35	MTR.
2	EQUAL. TEE -	250NBx250NBx250NB	01	NO.
3	90° BEND	250 NB	08	NOS.
4	ISOLATION GATE VALVE	250 NB	01	NO.
5	STRAINER	300 NB	01	NO.
6	REDUCER (CONCENTRIC)	400NBx250NBx300MM LONG	01	NO.
7	REDUCER (CONCENTRIC)	250NBx200NBx250MM LONG	02	NOS.
8	EXPANDER (CONCENTRIC)	250NBx200NBx300MM LONG	01	NO.
9	REDUCER (CONCENTRIC)	300NBx250NBx300MM LONG	01	NO.
LOCATION: PUMP DISCHARGE SIDE				
10	PIPE	200 NB	40	MTR.
11	LINE EQUAL. TEE-	300NBx300NBx200NB	01	NO.
12	90° BEND	200 NB	15	NOS.
13	ISOLATION GATE VALVE	200 NB	01	NO.
14	NON RETURN VALVE	200 NB	01	NO.
15	EXPANDER(CONCENTRIC)	150NBx100NBx150MM LONG	01	NO.
LOCATION: ARC LINE				
16	PIPE	65 NB	5	MTR.
17	PIPE	150 NB	30	MTR.
18	EXPANDER(CONCENTRIC)	65NBx100NBx100MM LONG	01	NO.
19	EXPANDER(CONCENTRIC)	100NBx150NBx150MM LONG	01	NO.
20	EQUAL. TEE -	150NBx150NBx150NB	01	NO.
21	90° BEND	150 NB	10	NOS.
22	ISOLATION GATE VALVE	150 NB	01	NO.
23	NON RETURN VALVE	150 NB	01	NO.
LOCATION: INTERMEDIATE TAKEOFF(TITO)LINE				
24	PIPE	100 NB	36	MTR.
25	EQUAL. TEE -	100NBx100NBx100NB	01	NO.
26	90° BEND	100 NB	15	NOS.
27	ISOLATION GATE VALVE	100 NB	01	NO.
28	NON RETURN VALVE	100 NB	01	NO.
LOCATION: BALANCING LINE				
29	PIPE	50NB	10	MTR.
30	EQUAL. TEE -	80NBx80NBx80NB	01	NO.
31	EXPANDER (CONCENTRIC)	50NBx80NBx100MM LONG	01	NO.
32	PIPE	80NB	35	MTR.
33	90° BEND	80NB	12	NOS.
34	ISOLATION GATE VALVE	50NB	01	NO.
35	NON RETURN VALVE	50NB	01	NO.

REFERENCE DRAWINGS:

DWG. NO.	DESCRIPTION
KFO-501009901000100	BOILER FEED PUMP GA DRAWING-R1
KEPL W/O NO. S050100990.	PUMP TAG NO. AGA-701

REV.	DATE	DESCRIPTION	PREP.	CHKD.	APPD.
1	05.07.2023	UPDATED AS PER CLIENT COMMENTS	SPU	SDS	DSS
2	03.10.2023	UPDATED AS PER CLIENT COMMENTS	SPU	SDS	DSS

PROJECT:
AMMONIA FEED STOCK
CHANGEOVER PROJECT, PANIPAT

OWNER:
NATIONAL FERTILIZERS LTD. INDIA

OWNER CONSULTANT:
 **KIRLOSKAR BROTHERS
LIMITED, PUNE (INDIA)**

CONTRACTOR:
 **KIRLOSKAR BROTHERS
LIMITED, PUNE (INDIA)**

PURPOSE OF DRAWING	NAME	DATE	TITLE:
FOR APPROVAL			BOILER FEED PUMP PIPING LAYOUT DRAWING
PREPARED	SPU	16.06.2023	
CHECKED	SDS	16.06.2023	
APPROVED	DSS/SSP	16.06.2023	

SCALE : AS SHOWN SHEET NO.:2 OF 2 REV. NO.:02 SHEET SIZE : A2

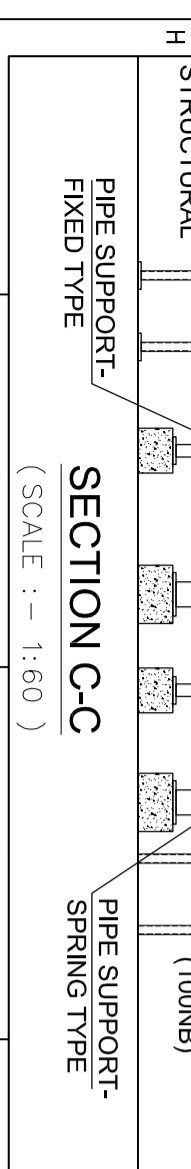
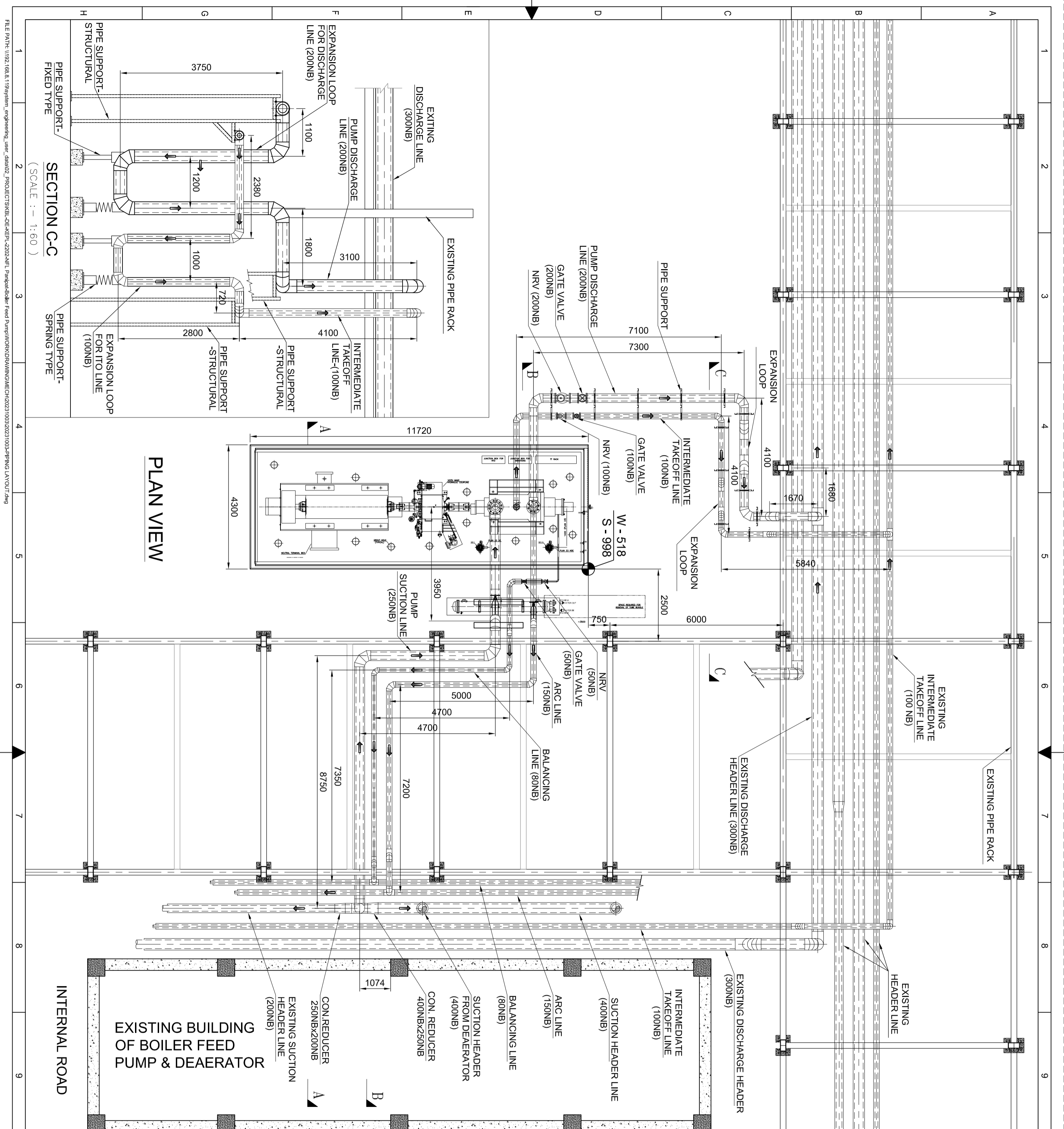

PLAN VIEW

EXISTING BUILDING OF BOILER FEED PUMP & DEAERATOR

INTERNAL ROAD

NOTES:

1. ALL DIMENSIONS ARE IN MM.
2. PIPING SHALL BE AS PER SPECIFICATIONS OF CLIENT.
3. SUPPORTS REQUIRED FOR PIPE ON PIPE RACK TO BE DECIDED SEPARATELY AT SITE BY CLIENT.
4. PIPE PRESSURE & TEMPERATURE RATING:
 - SUCTION LINE: PRESSURE RATING = CLASS #00, TEMP. = 131 DEGC.
 - BALANCING LINE: PRESSURE RATING = CLASS #00, TEMP. = 131 DEGC.
 - DISCHARGE LINE: PRESSURE RATING = CLASS #00, TEMP. = 131 DEGC.
 - INTERMEDIATE TAKEOFF LINE: PRESSURE RATING = CLASS #00, TEMP. = 131 DEGC.
 - ARC BYPASS LINE: PRESSURE RATING = CLASS #00, TEMP. = 131 DEGC.
5. PIPE MOCS:
 - PIPE MATERIAL: ASTM A106GR-B (RHS/SEAMLESS)
 - GASKET: RT-1 OCTAGONAL ASME B16.30 RT JON
 - (ABOVE PIPING MOCS IS CONSIDERED AS PER TECHNICAL SPECIFICATION DOCUMENT NUMBER D-501347BMA-P-59-000)
6. ALL PIPING SHALL BE PROVIDED WITH SUITABLE INSULATION & CADDINGS.
7. SIZE OF STRAINER AT PUMP SUCTION LINE SHALL BE 300 NB.
8. OVERHEAD PLATE (Ø CLASS#150) WITH FLANGES & GASKETS WILL BE LOOSE SUPPLY IN NETL SCOPE & TO BE INSTALLED NEAR DEWAERATOR.

BILL OF MATERIAL

SR NO.	ITEM NAME	SIZE	QTY.	UNIT
LOCATION PUMP SUCTION SIDE				
1	PIPE	250 NB	35	MTR.
2	EQUAL TEE -	250NBx250NBx250NB	01	NOS.
3	90° BEND	250 NB	08	NOS.
4	ISOLATION GATE VALVE	250 NB	01	NOS.
5	STRAINER	300 NB	01	NOS.
6	REDUCER (CONCENTRIC) -	400NBx250NBx300MM LONG	01	NOS.
7	REDUCER (CONCENTRIC) -	250NBx200NBx250MM LONG	02	NOS.
8	EXPANDER (CONCENTRIC) -	250NBx300NBx300MM LONG	01	NOS.
9	REDUCER (CONCENTRIC) -	300NBx250NBx300MM LONG	01	NOS.
LOCATION PUMP DISCHARGE SIDE				
10	PIPE	200 NB	40	MTR.
11	EQUAL TEE -	300NBx300NBx200NB	01	NOS.
12	90° BEND	200 NB	15	NOS.
13	ISOLATION GATE VALVE	200 NB	01	NOS.
14	NON RETURN VALVE	200 NB	01	NOS.
15	EXPANDER (CONCENTRIC) -	150NBx200NBx200MM LONG	01	NOS.
LOCATION ARC LINE				
16	PIPE	65 NB	5	MTR.
17	PIPE	150 NB	30	MTR.
18	EXPANDER (CONCENTRIC) -	65NBx100NBx100MM LONG	01	NOS.
19	EXPANDER (CONCENTRIC) -	100NBx150NBx150MM LONG	01	NOS.
20	EQUAL TEE -	150NBx150NBx150NB	01	NOS.
21	90° BEND	150 NB	10	NOS.
22	ISOLATION GATE VALVE	150 NB	01	NOS.
23	NON RETURN VALVE	150 NB	01	NOS.
LOCATION INTERMEDIATE TAKEOFF (ITO) LINE				
24	PIPE	100 NB	36	MTR.
25	EQUAL TEE -	100NBx100NBx100NB	01	NOS.
26	90° BEND	100 NB	15	NOS.
27	ISOLATION GATE VALVE	100 NB	01	NOS.
28	NON RETURN VALVE	100 NB	01	NOS.
LOCATION BALANCING LINE				
29	PIPE	50NB	10	MTR.
30	EQUAL TEE -	80NBx80NBx80NB	01	NOS.
31	EXPANDER (CONCENTRIC) -	50NBx80NBx100MM LONG	01	NOS.
32	PIPE	80NB	35	MTR.
33	90° BEND	80NB	12	NOS.
34	ISOLATION GATE VALVE	50NB	01	NOS.
35	NON RETURN VALVE	50NB	01	NOS.

REFERENCE DRAWINGS:

DWG. NO.	DESCRIPTION
KFO-501009901000100	BOILER FEED PUMP GA DRAWING-R1
KEPL W/O NO. S050100990.	PUMP TAG NO. AGA-701

REV.	DATE	DESCRIPTION	PREP.	CHKD.	APPD.
1	05.07.2023	UPDATED AS PER CLIENT COMMENTS	SPU	SDS	DSS
2	03.10.2023	UPDATED AS PER CLIENT COMMENTS	SPU	SDS	DSS

PROJECT:
AMMONIA FEED STOCK CHANGEOVER PROJECT, PANIPAT

OWNER:
NATIONAL FERTILIZERS LTD. INDIA

OWNER CONSULTANT:
 KIRLOSKAR BROTHERS LIMITED, PUNE (INDIA)

CONTRACTOR:
KIRLOSKAR BROTHERS LIMITED, PUNE (INDIA)

PURPOSE OF DRAWING:
FOR APPROVAL

PREPARED: SPU 16.06.2023

CHECKED: SDS 16.06.2023

APPROVED: DSS/SSP 16.06.2023

SCALE: AS SHOWN

TITLE: BOILER FEED PUMP PIPING LAYOUT DRAWING

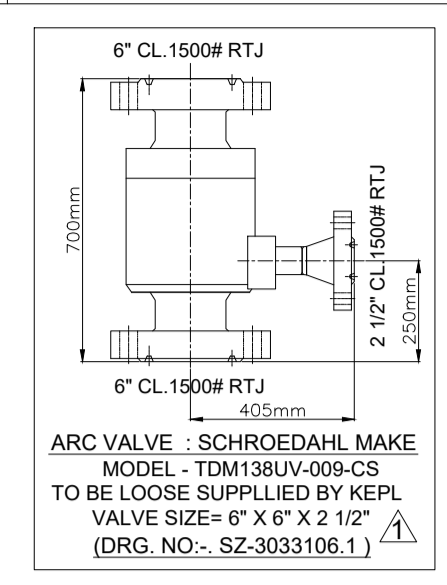
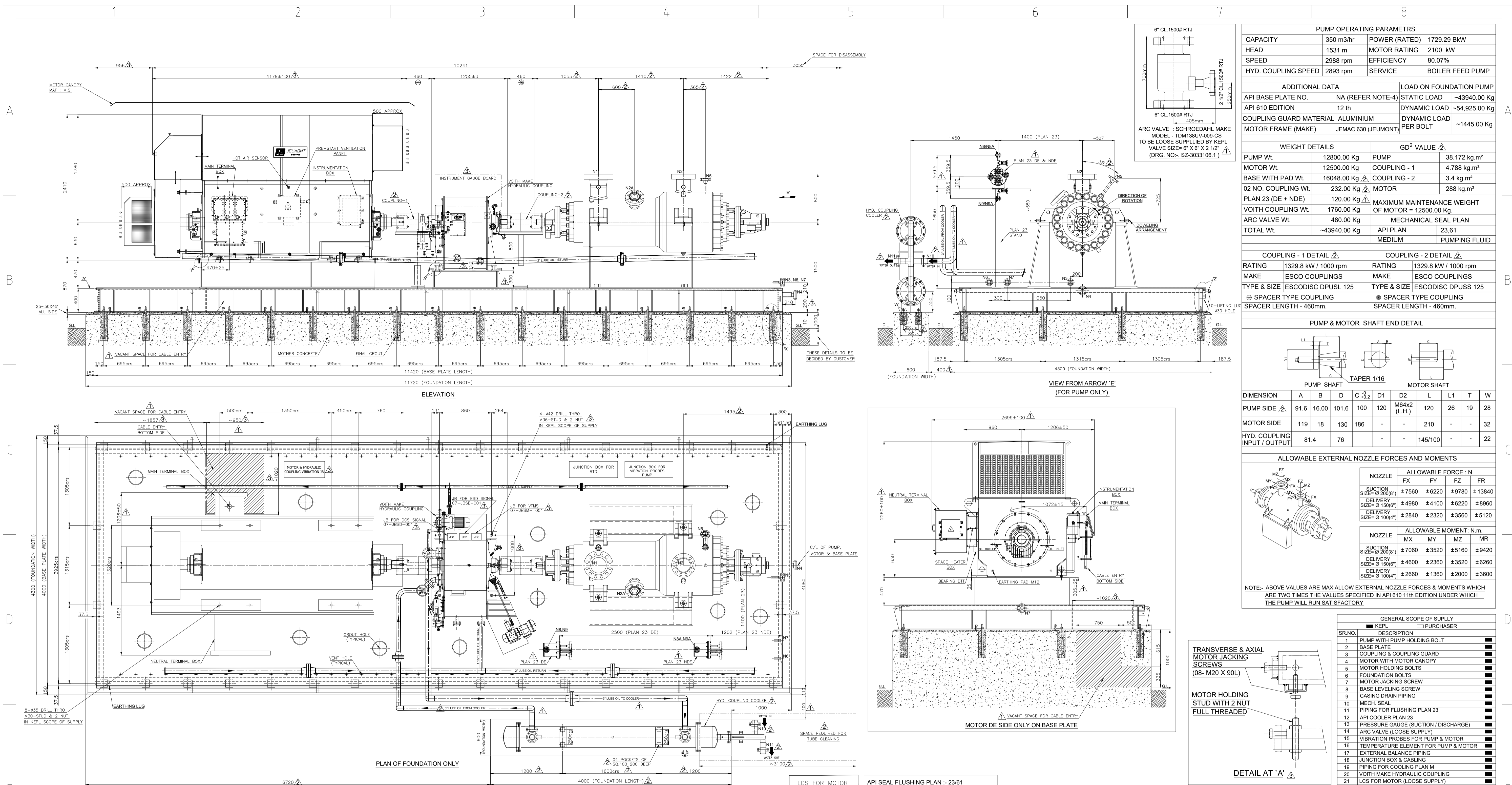

PUMP OPERATING PARAMETERS			
CAPACITY	350 m3/hr	POWER (RATED)	1729.29 BkW
HEAD	1531 m	MOTOR RATING	2100 kW
SPEED	2988 rpm	EFFICIENCY	80.07%
HYD. COUPLING SPEED	2893 rpm	SERVICE	BOILER FEED PUMP

ADDITIONAL DATA		LOAD ON FOUNDATION PUMP	
API BASE PLATE NO.	NA (REFER NOTE-4)	STATIC LOAD	~43940.00 Kg
API 610 EDITION	12 th	DYNAMIC LOAD	~54.925.00 Kg
COUPLING GUARD MATERIAL	ALUMINIUM	DYNAMIC LOAD PER BOLT	~1445.00 Kg
MOTOR FRAME (MAKE)	JEMAC 630 (JEUMONT)		

WEIGHT DETAILS		GD ² VALUE	
PUMP Wt.	12800.00 Kg	PUMP	38.172 kg.m ²
MOTOR Wt.	12500.00 Kg	COUPLING - 1	4.788 kg.m ²
BASE WITH PAD Wt.	16048.00 Kg	COUPLING - 2	3.4 kg.m ²
02 NO. COUPLING Wt.	232.00 Kg		288 kg.m ²
PLAN 23 (DE + NDE)	120.00 Kg		
VOITH COUPLING Wt.	1760.00 Kg	MAXIMUM MAINTENANCE WEIGHT OF MOTOR =	12500.00 Kg.
ARC VALVE Wt.	480.00 Kg	MECHANICAL SEAL PLAN	
TOTAL Wt.	~43940.00 Kg	API PLAN	23.61
		MEDIUM	PUMPING FLUID

COUPLING - 1 DETAIL		COUPLING - 2 DETAIL	
RATING	1329.8 kW / 1000 rpm	RATING	1329.8 kW / 1000 rpm
MAKE	ESCO COUPLINGS	MAKE	ESCO COUPLINGS
TYPE & SIZE	ESCODISC DPUSL 125	TYPE & SIZE	ESCODISC DPUSL 125
SPACER TYPE COUPLING	SPACER TYPE COUPLING	SPACER TYPE COUPLING	SPACER TYPE COUPLING
SPACER LENGTH - 460mm.	SPACER LENGTH - 460mm.	SPACER LENGTH - 460mm.	SPACER LENGTH - 460mm.

PUMP & MOTOR SHAFT END DETAIL										
	PUMP SHAFT					MOTOR SHAFT				
	A	B	D	C _{0.2}	D1	D2	L	L1	T	W
PUMP SIDE	91.6	16.00	101.6	100	120	M64x2 (L.H.)	120	26	19	28
MOTOR SIDE	119	18	130	186	-	-	210	-	-	32
HYD. COUPLING INPUT / OUTPUT	81.4	76	-	-	-	-	145/100	-	-	22

ALLOWABLE EXTERNAL NOZZLE FORCES AND MOMENTS				
NOZZLE	ALLOWABLE FORCE : N			
	FX	FY	FZ	FR
SUCTION SIZE= Ø 200(8")	±7560	±6220	±9780	±13840
DELIVERY SIZE= Ø 150(6")	±4980	±4100	±6220	±8960
DELIVERY SIZE= Ø 100(4")	±2840	±2320	±3560	±5120
NOZZLE	ALLOWABLE MOMENT : N.m			
	MX	MY	MZ	MR
SUCTION SIZE= Ø 200(8")	±7060	±3520	±5160	±9420
DELIVERY SIZE= Ø 150(6")	±4600	±2360	±3520	±6260
DELIVERY SIZE= Ø 100(4")	±2660	±1360	±2000	±3600

NOTE:- ABOVE VALUES ARE MAX.ALLOW EXTERNAL NOZZLE FORCES & MOMENTS WHICH ARE TWO TIMES THE VALUES SPECIFIED IN API 610 11th EDITION UNDER WHICH THE PUMP WILL RUN SATISFACTORY.

GENERAL SCOPE OF SUPPLY	
SR.NO.	DESCRIPTION
1	PUMP WITH PUMP HOLDING BOLT
2	BASE PLATE
3	COUPLING & COUPLING GUARD
4	MOTOR WITH MOTOR CANOPY
5	MOTOR HOLDING BOLTS
6	FOUNDATION BOLTS
7	MOTOR JACKING SCREW
8	BASE LEVELING SCREW
9	CASING DRAIN PIPING
10	MECH. SEAL
11	PIPING FOR FLUSHING PLAN 23
12	API COOLER PLAN 23
13	PRESSURE GAUGE (SUCTION / DISCHARGE)
14	ARC VALVE (LOOSE SUPPLY)
15	VIBRATION PROBES FOR PUMP & MOTOR
16	TEMPERATURE ELEMENT FOR PUMP & MOTOR
17	EXTERNAL BALANCE PIPING
18	JUNCTION BOX & CABLING
19	PIPING FOR COOLING PLAN M
20	VOITH MAKE HYDRAULIC COUPLING
21	LCS FOR MOTOR (LOOSE SUPPLY)

- NOTE :-
- ALL FLANGES HAVE SERRATED SPIRAL FINISH 125 TO 250 µ INCH.
 - GROUT BASEPLATE UP TO LEVEL 'A' AFTER ROUGH ALIGNMENT
 - ALL DIMENSIONS ARE IN mm UNLESS OTHERWISE SPECIFIED
 - OVERALL DIMENSIONS OF BASEPLATE ARE GREATER THAN LARGEST API BASE FRAME HENCE IT IS AS PER PUMP VENDORS STD.
 - BASEPLATE IS SUITABLE FOR CEMENTITIOUS GROUT.
 - ALL EQUIPMENTS, INSTRUMENTS, ACCESSORIES AND PIPING SHOWN IN THIS DRAWING ARE SCHEMATIC ONE AND ACTUAL SHAPE AND SIZE MAY DIFFER.
 - SHACKLE AS PER FEDERAL STANDARD RR-C-271D - PIN SIZE = 25mm (1") OR EQ.
 - PIPING BETWEEN PUMP SKID & HYD. COUPLING COOLER SHALL BE SUPPLIED LOOSE.
 - OIL DRAIN PIPING SHALL HAVE A MINIMUM SLOPE OF 1:50 (20 mm/m) OR 1".
 - EXTERNAL BALANCING LINE WITH COMPONENTS ARE SUPPLIED IN LOOSE.
 - SEPARATE JUNCTION BOX FOR TEMPERATURE (RTD) AND VIBRATION SIGNALS.
 - JB LOCATION WILL BE DECIDED DURING ACTUAL INSTALLATION ON SKID.
 - CABLING WITH CABLE TRAY FROM INSTRUMENTS TO JB WITHIN SKID IS IN KEPL SCOPE OF SUPPLY. CABLE TRAY INSTALLATION WITHIN SKID WILL BE AS PER KEPL PRACTICE.

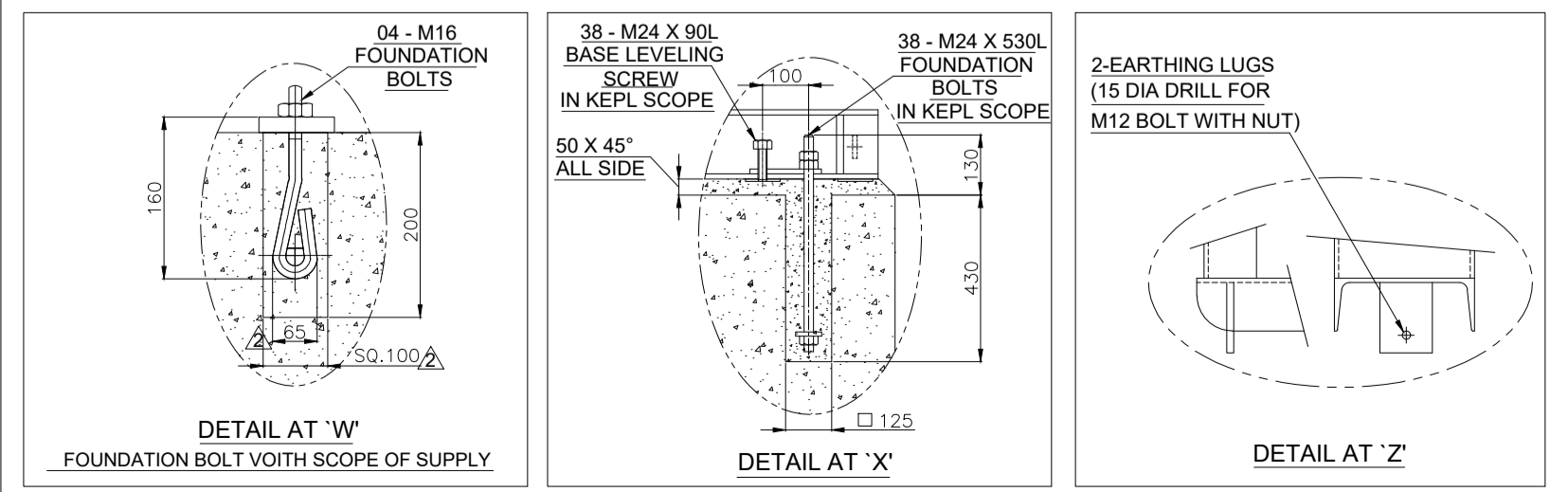

LOAD ON COOLER FOUNDATION		TOTAL COOLING WATER		
STATIC LOAD	~1023.60 Kg	PRESSURE [Kg/cm2(G)]	QUANTITY m3/hr.	TEMPERATURE [°C]
DYNAMIC LOAD	~1279.50 Kg	SUPPLY : 3.0 TO 4.0 (MAX.)	PLAN 23 COOLER (DE&NDE) = 3.0	SUPPLY : 35 (NOR.)
DYNAMIC LOAD PER BOLT	~319.875 Kg		HYD. COUPLING COOLER = 35.84	RETURN : 44 (MAX.)
			TOTAL = 38.84	

CUSTOMER INTERFACE CONNECTIONS					
SYMBOL	CONNECTION	SIZE (INCH)	TYPE	RATING	REMARK
N1	PUMP SUCTION	8	FLANGE	ASME B16.5 CL 1500# RTJ	WITH CLOSING PLATE
N2	PUMP DISCHARGE	6	FLANGE	ASME B16.5 CL 1500# RTJ	WITH CLOSING PLATE
N2A	INTERMEDIATE TAKE OFF NOZZLE	4	FLANGE	ASME B16.5 CL 1500# RTJ	WITH CLOSING PLATE
N3	PUMP CASING DRAIN	3/4	FLANGE	ASME B16.5 CL 2500# RTJ	WITH BLIND FLANGE
N4	PUMP BASE DRAIN	2	FLANGE	ASME B16.5 CL 150#	WITH BLIND FLANGE
N5	EXTERNAL BALANCE LINE	2	FLANGE	ASME B16.5 CL 2500# RTJ	WITH CLOSING PLATE
N6	COOLING WATER INLET	1	FLANGE	ASME B16.5 CL 150#	WITH CLOSING PLATE
N7	COOLING WATER OUTLET	1	FLANGE	ASME B16.5 CL 150#	WITH CLOSING PLATE
N8	PLAN 23 COOLER VENT (DE)	1/2	FLANGE	ASME B16.5 CL 150#	WITH BLIND FLANGE
N8A	PLAN 23 COOLER VENT (NDE)	1/2	FLANGE	ASME B16.5 CL 150#	WITH BLIND FLANGE
N9	PLAN 23 COOLER DRAIN (DE)	1/2	FLANGE	ASME B16.5 CL 150#	WITH BLIND FLANGE
N9A	PLAN 23 COOLER DRAIN (NDE)	1/2	FLANGE	ASME B16.5 CL 150#	WITH BLIND FLANGE
N10	COOLING WATER INLET (HYD CPLG. COOLER)	3	FLANGE	ASME B16.5 CL 150#	WITH COMP. FLANGE
N11	COOLING WATER OUTLET (HYD CPLG. COOLER)	3	FLANGE	ASME B16.5 CL 150#	WITH COMP. FLANGE

03	16.01.2024	REVISED AS PER COMMENTS	SHK	VVS	PSP
02	07.09.2023	REVISED AS PER COMMENTS	SHK	AKM	PSP
01	27.04.2023	REVISED AS PER COMMENTS	SHK	AKM	PSP
00	01.02.2023	FOR APPROVAL	SHK	AKM	KAS
REV	DATE	DESCRIPTION	DRN	CHD	APPD
KEPL W/O NO.	S050100990				
PUMP TYPE	200 X 150 DCD (336A17.5) 13 STAGE				
CLIENT	NATIONAL FERTILIZERS LIMITED, PANIPAT				
CONSULTANT	NA				
PROJECT	SUPPLY OF BOILER FEED WATER PUMP WITH DRIVE MOTOR AND VARIABLE SPEED HYDRAULIC COUPLING FOR NFL AMMONIA PLANT				
LOI No. / PO No.	NVFP-MM:SB/210077-J:LOI				
DRG. No.	KFO 50100990 100 0100				

GENERAL ARRANGEMENT AND FOUNDATION PLAN DRAWING

KIRLOSKAR EBARA PUMPS LTD.
 PRIDE KUMAR SENATE BLDG. SENAPATI BAPAT ROAD.
 PUNE - 411 016 (INDIA)

SHEET NO. 01 OF 05



Larsen & Toubro Limited

AFC PROJECT

FORMAT -LT/AFC/WPS/PIPE/011 Rev.00

NFL-PANIPAT



OWNER: M/s NATIONAL FERTILIZERS LIMITED

PMC: PDIL

CONTRACTOR: L&T

QW-482 WELDING PROCEDURE SPECIFICATION ASME SEC.IX, BOILER & PRESSURE VESSEL CODE

SUPPORTING PQR No.: PQR/PCS/004

WPS No. : WPS/PIPE/003

DATE : 31.03.2008

REV.

WELDING PROCESS : GTAW+SMAW

DATE : 25.06.2010

REV.

0

JOINTS(QW-402)

JOINT DESIGN SINGLE 'V' BUTT WELD (J Groove 22mm & Above)
BACKING USED WITH OR WITHOUT WELD METAL
BACKING MATERIAL

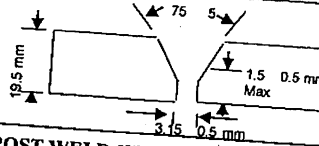

BASE METALS(QW-403)

MATERIAL SPEC A106 Gr. B or Equivalent
TYPE OR GRADE Gr. B
P.NO TO P.NO. P1 / Gr. 1 & 2 to P1 / Gr. 1 & 2
THICKNESS RANGE(GROOVE) 5 MM TO 39 MM
THICKNESS RANGE(FILLET) ALL THICKNESS
PIPE DIA. RANGE(GROOVE) ALL
PIPE DIA. RANGE(FILLET) ALL SIZE

POST WELD HEAT TREATMENT (QW-407)

TEMPERATURE RANGE 610 ± 10° C
TIME (Min.) 1 Hr. / 1" thickness min.
HEATING/COOLING RATE 200° C

GAS(QW-408)

Table with columns: GASES, MIXTURE, FLOW RATE, PERCENT COMPOSITION. Values include Argon 99.995%, 10-15 LPM.

FILLER METAL(QW-404)

Table with columns: SFA SPEC, AWS CLASS, F-NO, A-NO, SIZE OF FILLER METAL, DEPOSITED WELD METAL THK., THICKNESS RANGE FOR GROOVE, THICKNESS RANGE FOR FILLET. Values include GTAW 5.18, SMAW 5.1, ER-70S2, E7018.

ELECTRICAL CHARACTERISTICS (QW-409)

Table with columns: CURRENT, POLARITY, TUNGSTEN SIZE & TYPE, MODE OF METAL TRANSFER, WIRE FEED SPEED RANGE, OTHER. Values include DC, 60-160A, 2.4MM.

TECHNIQUE (QW-410)

Table with columns: POSITION OF GROOVE, WELDING PROGRESSION, POSITION OF FILLET, PREHEAT TEMP, PREHEAT MAINTAINCE, POST HEATING. Values include 6G, UP HILL, ALL, 100°C for > 25MM.

PREHEAT(QW-406)

Table with columns: PREHEAT TEMP. (Min.), PREHEAT TEMP. (Max.), PREHEAT MAINTAINCE, POST HEATING. Values include 100°C for > 25MM, 250°C, YES, NA.

Table with columns: WELD LAYERS, PROCESS, FILLER METAL CLASS, DIA., TYPE AND POLARITY, AMP RANGE, VOLT RANGE, TRAVEL SPEED RANGE. Values include 1-5 layers, GTAW, SMAW, ER-70S2, E-7018.

Prepared by H.S.ROUT, Checked by D.D.BANERJEE, Approved by S. Bhattacharya

ONLY OWNER / PMC APPROVED BRANDS OF ELECTRODE SHALL BE USED.